



Antennas

DATA SHEET

Hybrid Multiband Beamforming Antenna

12HBF4R-BUH8NA

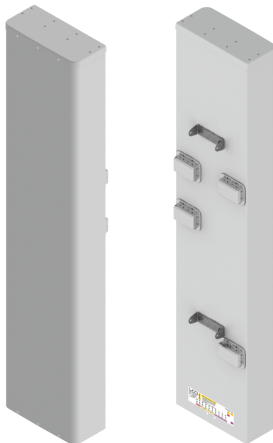

- Eight foot(2.4 m), Hybrid Multiband Beamforming Antenna, deploying a high performing 65° azimuth beamwidth covering 698-896 MHz/1695-2400 MHz frequencies and an 8T8R Beamforming array covering 3300-4200 MHz
- Four wide low band ports covering 698-896 MHz, Eight wide mid band ports covering 1695-2400 MHz and Eight wide high band ports covering 3300-4200 MHz, in a single antenna
- Full Spectrum Compliance for 698-896 MHz/1695-2400 MHz/3300-4200 MHz
- Provides an 8T8R Beamforming array, with a calibration port, for RRU controlled Azimuth beam control and beamforming, for increased 5G services data throughput and decreased latency, by minimizing interference and increasing signal strength at directed users
- Beamforming array can be deployed with tapering (or without tapering), for improved Azimuth SLL performance
- LTE Optimized FBR, SPR and Boresight/Sector XPD Performance, essential for today's LTE Data Networks
- Exceeds minimum PIM performance requirements
- Equipped with new 4.3-10 connector, which is 40% smaller than traditional 7/16 DIN connector
- Equipped with Four Field Replaceable, integrated AISG 2.0 compliant Remote Electrical Tilt (RET)

Overview

The CCI Hybrid Multiband Array with 3.5 GHz 8T8R Support is a Twenty port antenna, with Four wide low band ports covering 698-896 MHz, Eight wide mid band ports covering 1695-2400 MHz and Eight wide high band ports covering 3300-4200 MHz. The CCI Hybrid Multiband Array with 3.5 GHz 8T8R Support uses a high performance 65° azimuth beamwidth in the low band and mid band frequencies and an 8T8R Beamforming array in the high band frequencies.

The CCI Hybrid Multiband Beamforming Antenna provides the capability to deploy a Single 4x4 Multiple-input Multiple-output in the low band, Dual 4x4 Multiple-input Multiple-output (MIMO) in the mid band and 8T8R Beamforming in the high band. The CCI Hybrid Multiband Beamforming Antenna utilizes four Type 17 RET controllers, with one RET control for the Low Band ports, two RET controls in the Mid Band ports and one RET control for the 8T8R Beamforming array.

The CCI Hybrid Multiband Beamforming Antenna, will allow operators to reduce OPEX and CAPEX costs, by having a high performing 8T8R array, integrated into Twelve port 65° multiband array, all within a single antenna enclosure.

CCI antennas are designed and produced to ISO 9001 certification standards for reliability and quality in our state-of-the-art manufacturing facilities.

Applications

- 8T8R Beamforming, supporting 3.3 - 4.2 GHz, with calibration port
- Single 4X4 MIMO Low Band ports and Dual 4x4 MIMO for the Mid Band ports
- With CCI's Hybrid Multiband Beamforming Antennas, wireless providers can connect multiple platforms to a single antenna, reducing tower load, lease expense, deployment time and installation costs



Antennas

SPECIFICATIONS

Hybrid Multiband Beamforming Antenna

12HBF4R-BUH8NA

Electrical

Ports	4 x Low Band Ports for 698-896 MHz	
	698-806 MHz	824-896 MHz
Frequency Range	698-806 MHz	824-896 MHz
Gain ¹	15.6 dBi	16.6 dBi
Gain (Average)	14.7 dBi	15.6 dBi
Azimuth Beamwidth (-3dB)	74°	64°
Elevation Beamwidth (-3dB)	9.8°	8.2°
Electrical Downtilt	2° to 12°	2° to 12°
Elevation Sidelobes (1st Upper)	<-18 dB	<-18 dB
Front-to-Back Ratio @180°	> 35 dB	> 35 dB
Front-to-Back Ratio ±20°	> 33 dB	> 35 dB
Cross-Polar Discrimination at Peak	> 25 dB	> 25 dB
Cross-Polar Port-to-Port Isolation	> 25 dB	> 25 dB
Voltage Standing Wave Ratio (VSWR)	< 1.5:1	
Passive Intermodulation (2x20W)	≤ -153 dBc	
Input Power Continuous Wave (CW)	500 watts	
Polarization	Dual Linear 45°	
Input Impedance	50 ohms	
Lightning Protection	DC Ground	

¹Peak gain across sub-bands.

Ports	8 x Mid Band Ports for 1695-2400 MHz			
	1695-1880 MHz	1850-1990 MHz	1920-2180 MHz	2300-2400 MHz
Frequency Range	1695-1880 MHz	1850-1990 MHz	1920-2180 MHz	2300-2400 MHz
Gain ¹	18.0 dBi	18.2 dBi	18.3 dBi	17.8 dBi
Gain (Average)	16.7 dBi	17.2 dBi	17.3 dBi	17.1 dBi
Azimuth Beamwidth (-3dB)	69°	66°	66°	60°
Elevation Beamwidth (-3dB)	5.7°	5.1°	4.8°	4.1°
Electrical Downtilt	0° to 8°	0° to 8°	0° to 8°	0° to 8°
Elevation Sidelobes (1st Upper)	<-18 dB	<-18 dB	<-18 dB	<-17 dB
Front-to-Back Ratio @180°	> 35 dB	> 35 dB	> 35 dB	> 35 dB
Front-to-Back Ratio ±20°	> 33 dB	> 33 dB	> 33 dB	> 33 dB
Cross-Polar Discrimination at Peak	> 18 dB	> 18 dB	> 20 dB	> 21 dB
Cross-Polar Port-to-Port Isolation	> 25 dB	> 25 dB	> 25 dB	> 25 dB
Voltage Standing Wave Ratio (VSWR)	< 1.5:1			
Passive Intermodulation (2x20W)	≤ -153 dBc			
Input Power Continuous Wave (CW)	300 watts			
Polarization	Dual Linear 45°			
Input Impedance	50 ohms			
Lightning Protection	DC Ground			

¹Peak gain across sub-bands.



Antennas

SPECIFICATIONS

Hybrid Multiband Beamforming Antenna

12HBF4R-BUH8NA

Electrical

Ports	8 x High Band Ports for 3300-4200 MHz			
	Single Column			
Frequency Range	3300-3400 MHz	3450-3550 MHz	3700-4000 MHz	4000-4200 MHz
Gain ¹	16.4 dBi	16.0 dBi	16.7 dBi	16.7 dBi
Gain (Average)	15.3 dBi	15.4 dBi	15.4 dBi	15.5 dBi
Azimuth Beamwidth (-3dB)	57.1° ±32.5°	77.3° ±8.1°	76.9° ±14.8°	72.7° ±20.7°
Elevation Beamwidth (-3dB)	7.7°	7.5°	6.9°	6.3°
Electrical Downtilt	2° to 12°	2° to 12°	2° to 12°	2° to 12°
Elevation Sidelobes (1st Upper)	< -18 dB	< -18 dB	< -19 dB	< -18 dB
Front-to-Back Ratio @180°	> 33 dB	> 30 dB	> 34 dB	> 32 dB
Front-to-Back Ratio ±20°	> 28 dB	> 28 dB	> 28 dB	> 26 dB
Cross-Polar Discrimination at Peak	> 20 dB	> 18 dB	> 18 dB	> 17 dB
CoPol Isolation between Columns	> 20 dB	> 22 dB	> 25 dB	> 25 dB
Cross-Polar Isolation	> 20 dB	> 22 dB	> 25 dB	> 25 dB
Coupling level, antenna port to cal port	26 ±2	26 ±2	26 ±2	26 ±2
Max Amplitude difference between antenna ports and Cal port (dB)	< ±1	< ±1	< ±1	< ±1
Max phase difference between antenna ports and Cal port (deg)	< ±7	< ±7	< ±7	< ±7
Voltage Standing Wave Ratio (VSWR)	< 1.5:1	< 1.5:1	< 1.5:1	< 1.5:1
Passive Intermodulation (2x20W)	≤ -153 dBc	≤ -153 dBc	≤ -153 dBc	≤ -153 dBc
Input Power Continuous Wave (CW)	100 watts	100 watts	100 watts	100 watts
Polarization	Dual Linear 45°	Dual Linear 45°	Dual Linear 45°	Dual Linear 45°
Input Impedance	50 ohms	50 ohms	50 ohms	50 ohms
Lightning Protection	DC Ground	DC Ground	DC Ground	DC Ground

¹Peak gain across sub-bands.

Ports	Broadcast and Service Beams			
	Broadcast		Service Beam at 0°*	
Frequency Range	3300-3600 MHz	3700-4200 MHz	3300-3600 MHz	3700-4200 MHz
Gain ¹	16.8 dBi	17.4 dBi	20.4 dBi	21.3 dBi
Gain (Average)	16.1 dBi	16.6 dBi	19.8 dBi	20.6 dBi
Azimuth Beamwidth (-3dB)	72.0° ±3.4°	70.2° ±9.8°	29.0° ±1.5°	23.5° ±2.3°
Elevation Beamwidth (-3dB)	7.7°	6.9°	7.8°	6.8°
Electrical Downtilt	2° to 12°	2° to 12°	2° to 12°	2° to 12°
Elevation Sidelobes (1st Upper)	< -19 dB	< -18 dB	< -18 dB	< -18 dB
Front-to-Back Ratio @180°	> 33 dB	> 34 dB	> 35 dB	> 35 dB
Front-to-Back Ratio ±20°	> 29 dB	> 27 dB	> 34 dB	> 35 dB

¹Peak gain across sub-bands.

* Performance is based on no tapering applied



Antennas

SPECIFICATIONS

Hybrid Multiband Beamforming Antenna

12HBF4R-BUH8NA

Electrical

Ports	Service Beams and Soft BiSector			
	Service Beam at 30°*		Service Beam Soft BiSector	
Frequency Range	3300-3600 MHz	3700-4200 MHz	3300-3600 MHz	3700-4200 MHz
Gain ¹	20.4 dBi	20.4 dBi	20.6 dBi	20.1 dBi
Gain (Average)	19.6 dBi	19.5 dBi	19.7 dBi	19.2 dBi
Azimuth Beamwidth (-3dB)	25.5° ±1.8°	27.0° ±3.5°	25.6° ±3.1°	31.1° ±3.3°
Elevation Beamwidth (-3dB)	7.6°	6.7°	7.7°	6.7°
Electrical Downtilt	2° to 12°	2° to 12°	2° to 12°	2° to 12°
Elevation Sidelobes (1st Upper)	< -18 dB	< -20 dB	< -18 dB	< -20 dB
Front-to-Back Ratio @180°	> 38 dB	> 38 dB	> 35 dB	> 32 dB
Front-to-Back Ratio ±20°	> 34 dB	> 33 dB	> 33 dB	> 30 dB

¹Peak gain across sub-bands.

* Performance is based on no tapering applied

Mechanical

Dimensions (LxWxD)	95.9x20.6x9.2 in (2436x524x234 mm)
Survival Wind Speed	> 150 mph (> 241 kph)
Front Wind Load ¹	324 lbf @ 100 mph 1441 N @ 161 kph
Side Wind Load ¹	105 lbf @ 100 mph 467 N @ 161 kph
Effective Projective Area (EPA), Front ¹	12.9 ft ² (1.2 m ²)
Weight *	105.2 lbs (47.7 kg)
RF Connector	20 x 4.3-10 female
Calibration Interface	1 x 4.3-10 female
RET Connectors	1 female / 1 male
RET Interface	8-pin D female / 8-pin D male
Mounting Pole	2 to 5 in (5 to 12 cm)

¹Windload values calculated using CFD analysis

* Weight excludes mounting



Antennas

SPECIFICATIONS Hybrid Multiband Beamforming Antenna

12HBF4R-BUH8NA

Mechanical

Bottom View

12HBF4R-BUH8NA

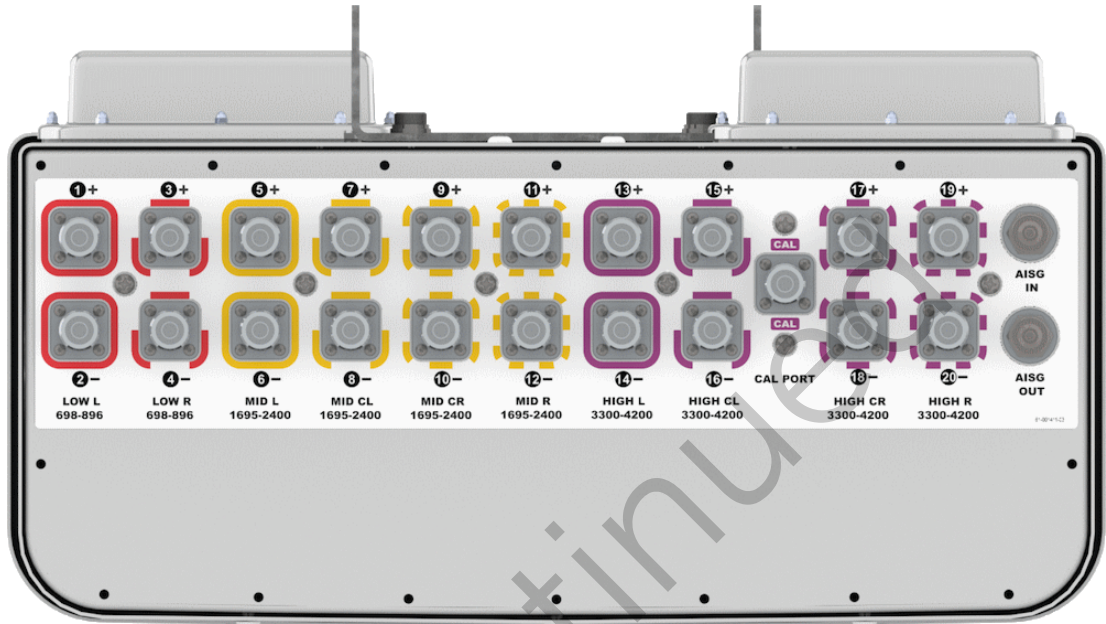

Connector Spacing

12HBF4R-BUH8NA

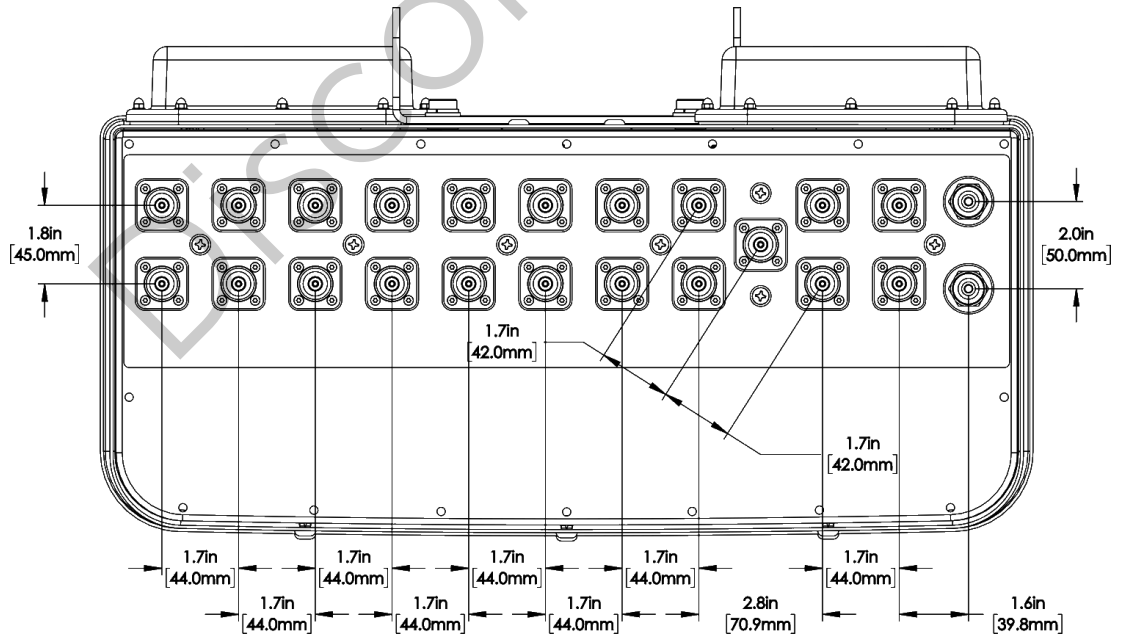



Antennas

SPECIFICATIONS

Hybrid Multiband Beamforming Antenna

12HBF4R-BUH8NA

Mechanical

RET to Element Configuration

12HBF4R-BUH8NAB Element and RET configuration (Type 17 Internal RET)

**Top of antenna
Viewed from rear**

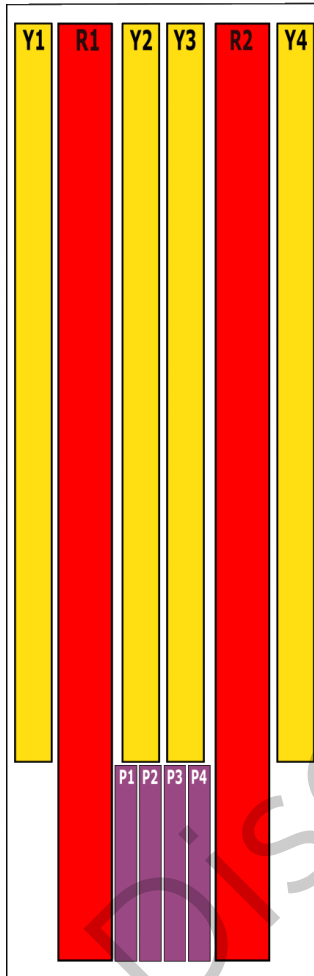

**RET placement
as viewed from rear
of antenna**

Top of antenna



Array	Ports	Freq (MHz)	Ports controlled by common RET	AISG RET UID
R1	1, 2	698-896	1, 2, 3, 4	C1xxxxxxMM.1
R2	3, 4	698-896		
Y1	5, 6	1695-2400	5, 6, 7, 8	C1xxxxxxMM.2
Y2	7, 8	1695-2400		
Y3	9, 10	1695-2400		
Y4	11, 12	1695-2400	9, 10, 11, 12	C1xxxxxxMM.3
P1	13, 14	3300-4200		
P2	15, 16	3300-4200		
P3	17, 18	3300-4200		
P4	19, 20	3300-4200	13, 14, 15, 16, 17, 18, 19, 20	C1xxxxxxMM.4



Antennas

SPECIFICATIONS

Hybrid Multiband Beamforming Antenna

12HBF4R-BUH8NA

Typical Antenna Patterns

For detailed information on additional antenna patterns, contact customer support at support@cciproducts.com

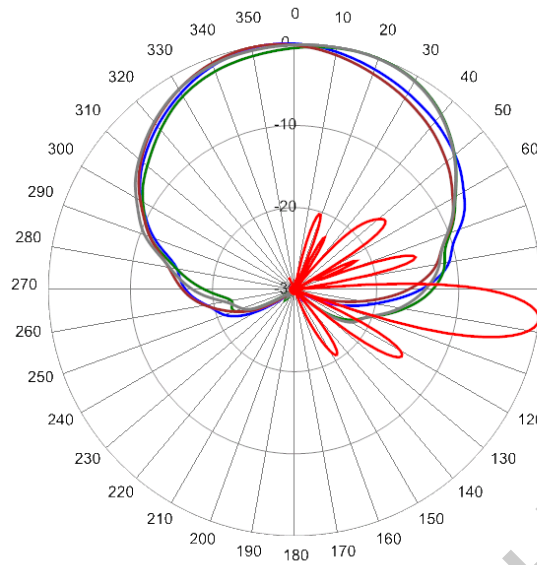

734 MHz Azimuth with Elevation 7°

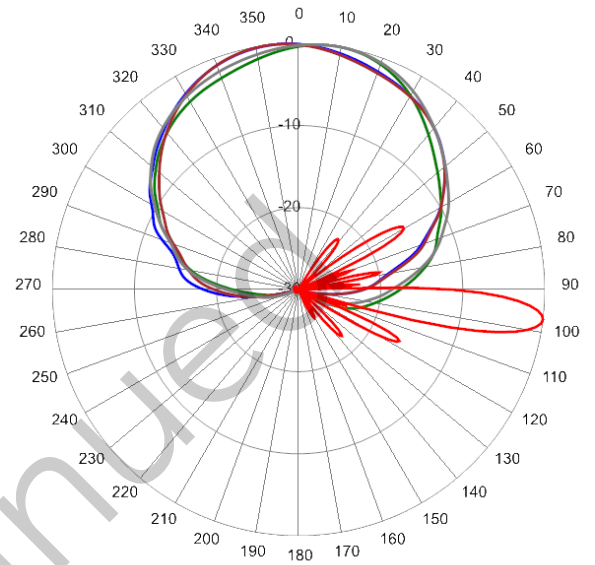

880 MHz Azimuth with Elevation 7°

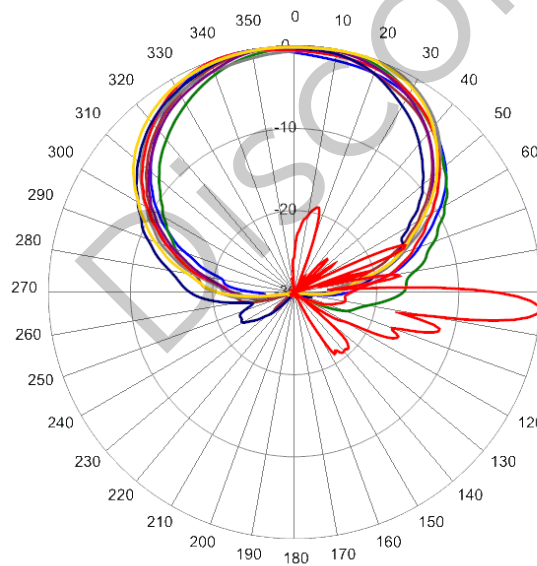

1720 MHz Azimuth with Elevation 4°

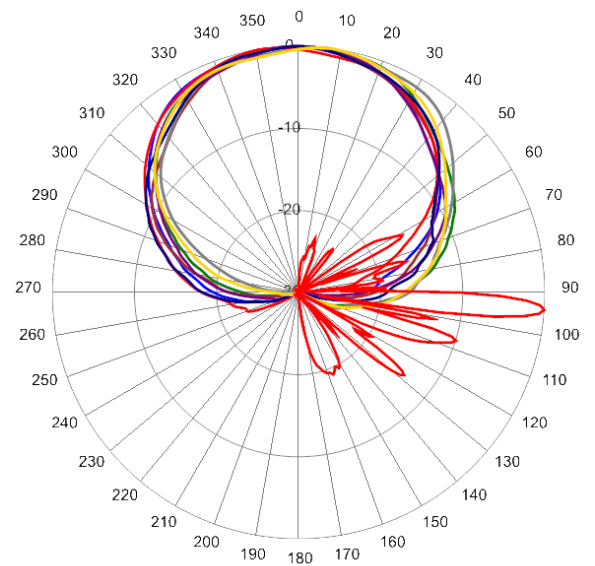

2155 MHz Azimuth with Elevation 4°



Antennas

SPECIFICATIONS

Hybrid Multiband Beamforming Antenna

12HBF4R-BUH8NA

Typical Antenna Patterns

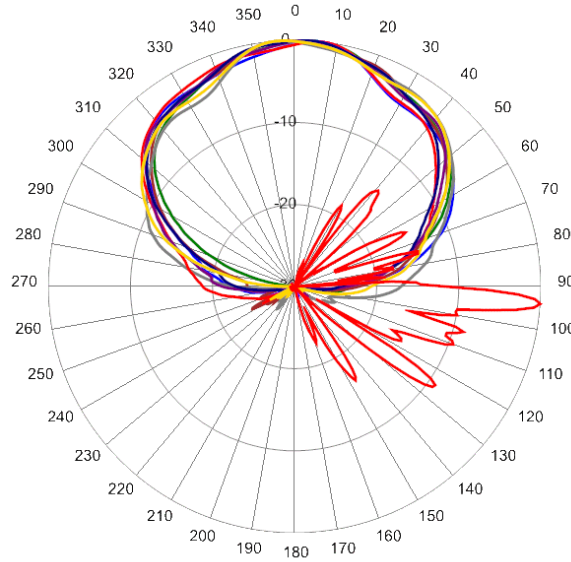

2360 MHz Azimuth with Elevation 4°

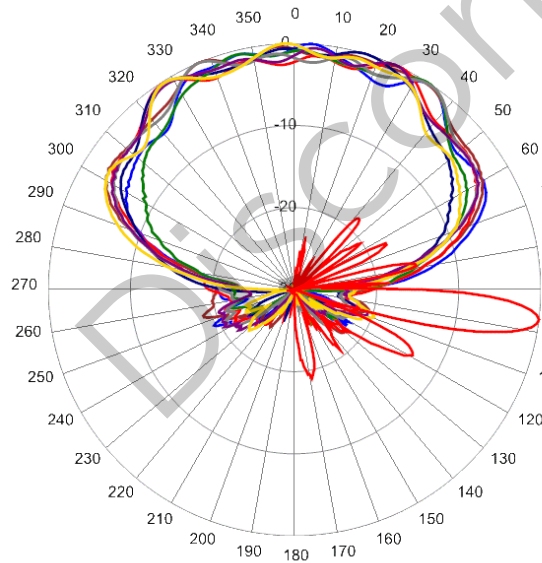

3500 MHz Azimuth with Elevation 7° Single Column

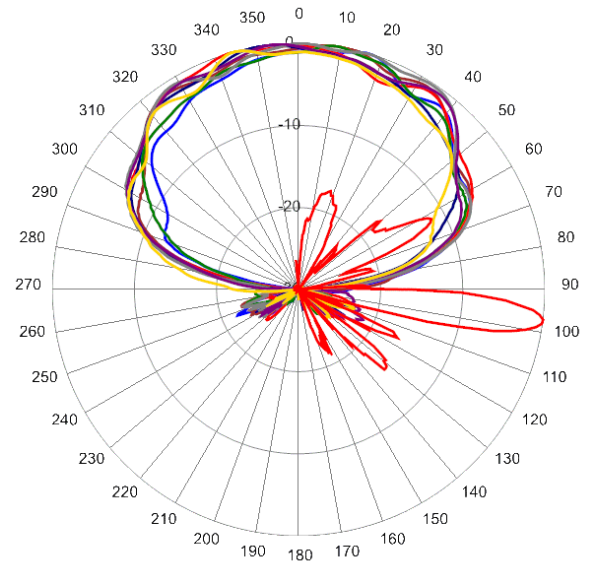

3920 MHz Azimuth with Elevation 7° Single Column



Antennas

SPECIFICATIONS

Hybrid Multiband Beamforming Antenna

12HBF4R-BUH8NA

Typical Antenna Patterns

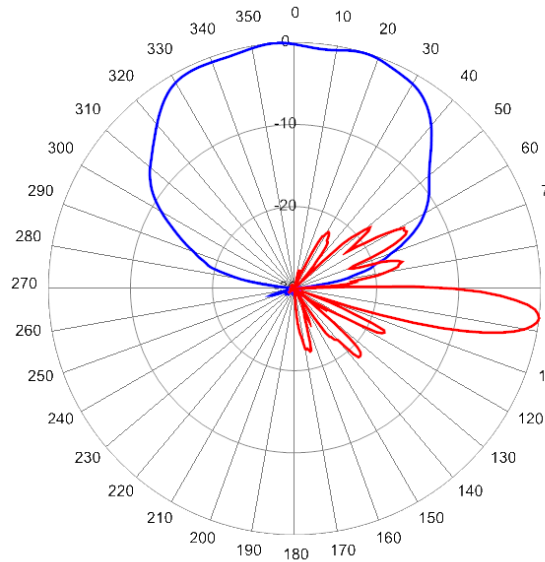

3500 MHz Azimuth with Elevation 7° Broadcast Beam

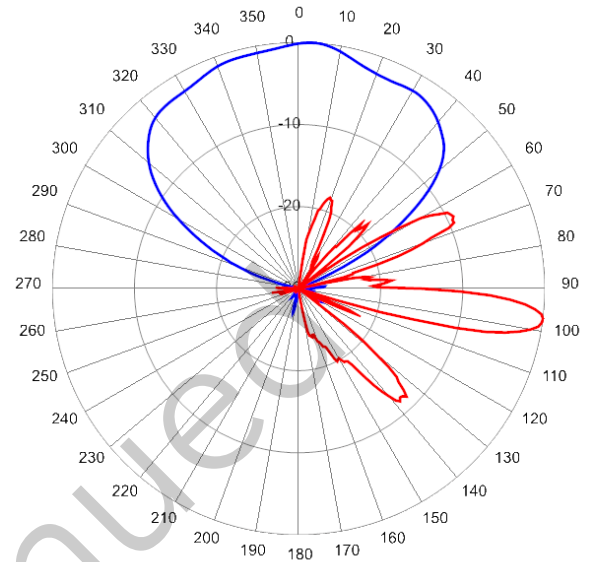

3920 MHz Azimuth with Elevation 7° Broadcast Beam

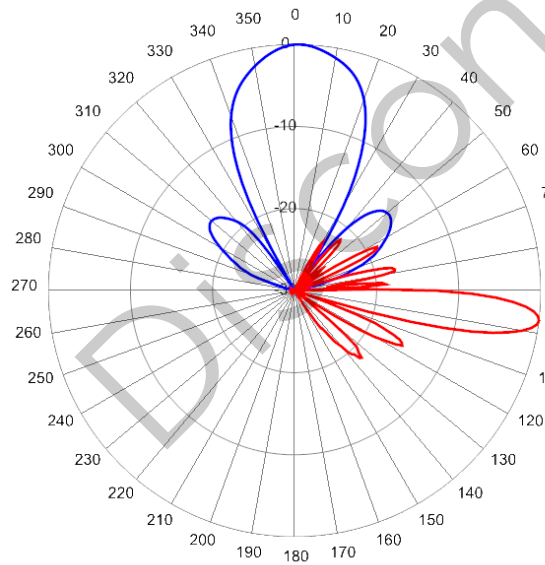

3500 MHz Azimuth 0° with Elevation 7° Service Beam

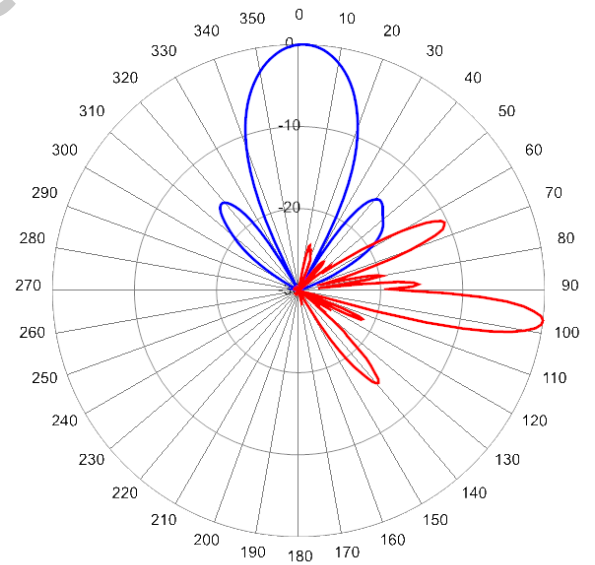

3920 MHz Azimuth 0° with Elevation 7° Service Beam



Antennas

SPECIFICATIONS

Hybrid Multiband Beamforming Antenna

12HBF4R-BUH8NA

Typical Antenna Patterns

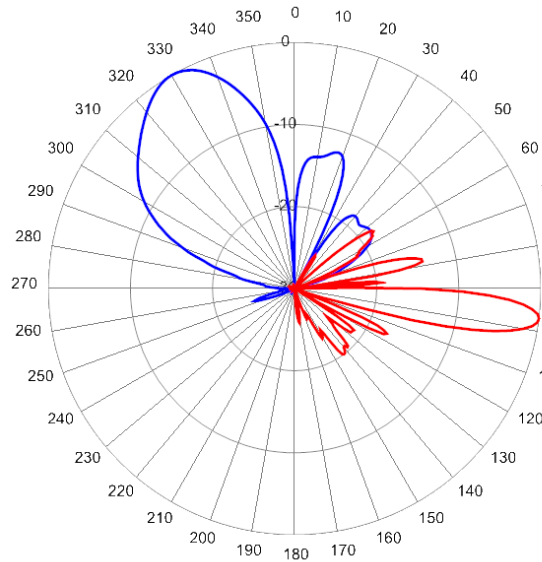

3500 MHz Azimuth 30° with Elevation 7° Service Beam

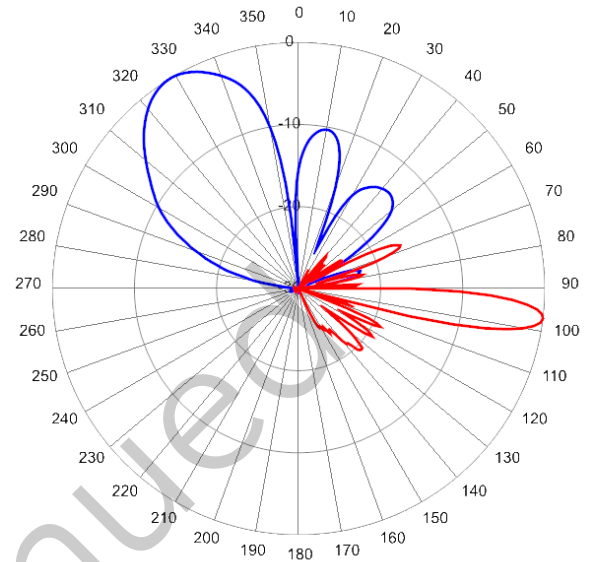

3820 MHz Azimuth 30° with Elevation 7° Service Beam

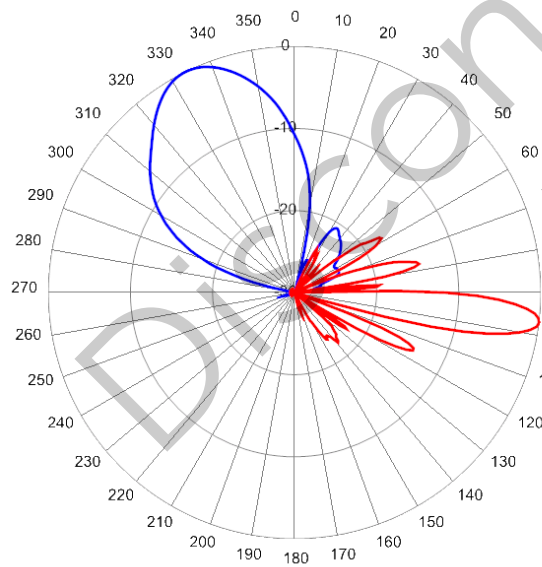

3500 MHz Azimuth with Elevation 7° Soft Split

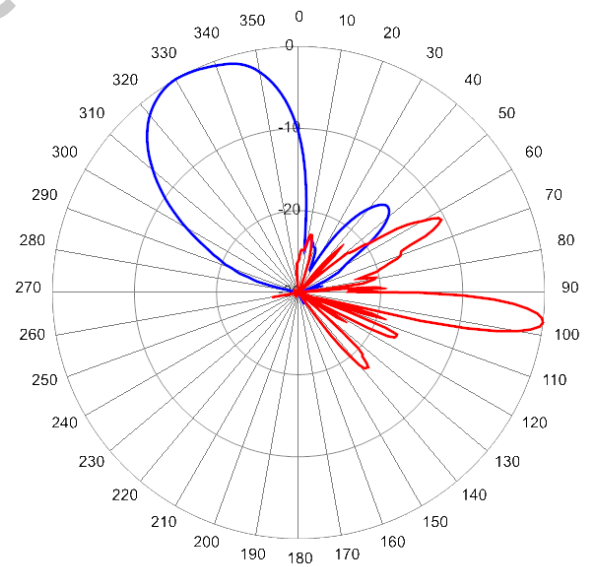

3920 MHz Azimuth with Elevation 7° Soft Split

For detailed information on additional antenna patterns, contact customer support at support@cciproducts.com



Antennas

ORDERING

Hybrid Multiband Beamforming Antenna

12HBF4R-BUH8NA

Parts & Accessories

12HBF4R-BUH8NAB-K Eight foot (2.4 m), Hybrid Multiband Beamforming Antenna, 21x 4.3-10 female connectors (including 1 calibration port), 4 factory installed BSA-RET400 RET actuators (Type 17 Internal) and MBK-16 mounting bracket

MBK-16 Mounting bracket kit (top and bottom) with fixed 0° mechanical tilt

MBK-01 Mounting bracket kit (top and bottom) with 0° to 10° mechanical tilt adjustment

BSA-RET400 Type 17 Remote electrical tilt actuator

AISGC-M-F-10FT 10 Ft (3 m) Male/Female RRU to Antenna AISG cable

Discontinued



Antennas

ACCESSORIES

Mounting Bracket Kit

MBK-16

Mechanical

Weight	9.9 lbs (4.5 kg)
Hinge Pitch	47.25 in (1200 mm)
Mounting Pole Dimension	2 to 5 in (5 to 12 cm)
Fastener Size	M12
Installation Torque	40 ft·lbs (54 N·m)
Mechanical Tilt	0°

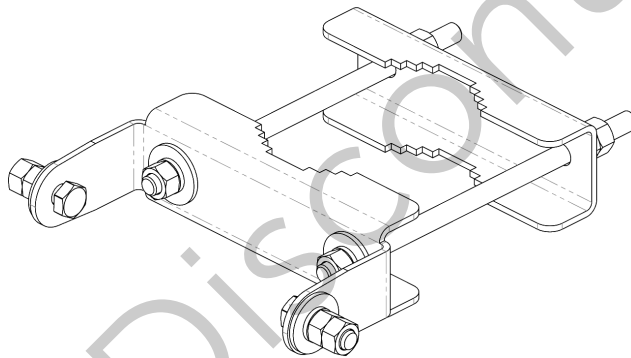
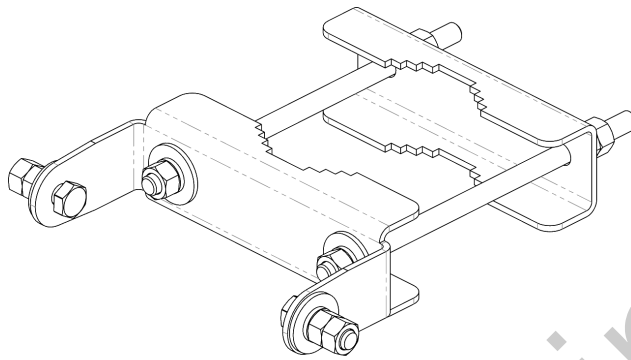

MBK-16 Top and Bottom Bracket



Antennas

ACCESSORIES

Mounting Bracket Kit

MBK-01

Mechanical

Weight	12.6 lbs (5.7 kg)
Hinge Pitch	47.25 in (1200 mm)
Mounting Pole Dimension	2 to 5 in (5 to 12 cm)
Fastener Size	M12
Installation Torque	40 ft·lb (54 N·m)
Mechanical Tilt Adjustment	0° - 10°

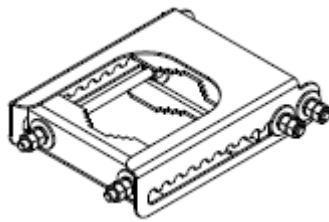

MBK-01 Top Adjustable Bracket

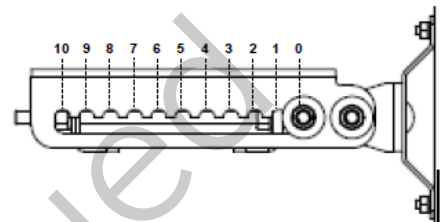

MBK-01 Top Adjustable Bracket Side View

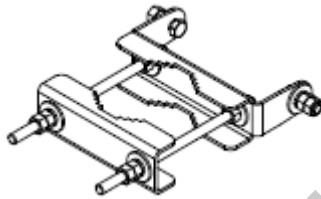

MBK-01 Bottom Fixed Bracket

Discontinued



Antennas

ACCESSORIES

Internal Remote Electrical Tilt (iRET)

BSA-RET400

General Specifications

Part Number	BSA-RET400
Protocols	AISG 2.0
RET Type	Type 17
Adjustment Cycles	>10,000 cycles
Tilt Accuracy	±0.1°
Temperature Range	-40° C to 70° C

Electrical

Data Interface Signal	DC
Input Voltage	10-30 Vdc
Current Consumption Tilt	100 mA at $V_{in}=24$ (500 mA MAX)
Current Consumption Idle	10 mA at $V_{in}=24$

Mechanical

Dimensions (LxWxD)	7.0x5.3x1.8 in. (179x134x45 mm)
Housing	ASA/ABS/Aluminum
Weight	1.3 lbs (0.6 kg)

ASA= Acrylic Styrene Acrylonitrile
ABS=Acrylonitrile Butadiene Styrene

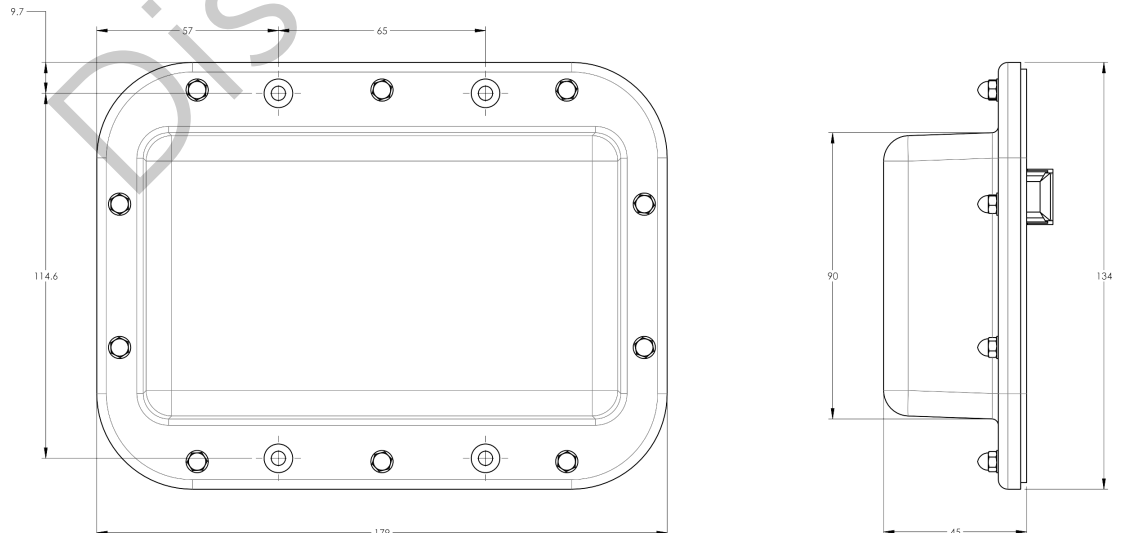



Antennas

ACCESSORIES

AISG Cable

AISGC-M-F-xFT

Electrical Specifications

Individual Cable Part Number	AISGC-M-F-x(FT)
Cable style	UL2464
Protocol	AISG 1.1 and AISG 2.0
Maximum voltage	300 V
Rated current	5 A at 104° F (40° C)

Mechanical Specifications

Individual Cable Part Number	AISGC-M-F-x(FT)
Cables per kit	1
Connectors	2 x 8 pin IEC 60130-9 Straight male/straight female
Tightening torque	Hand tighten only \approx 1.84 ft-lbs (2.5 Nm)
Construction	Shielded (Tinned Copper Braid)
Braid coverage	85%
Jacket Material	Matte Polyurethane (Black)
Conductors	1 twisted pair - 24 AWG 3 conductors - 19 AWG AWM style 2464
Cable Diameter	0.307 in (7.8 mm)
Length	See order details
Minimum bend radius	3.15 in (80 mm)

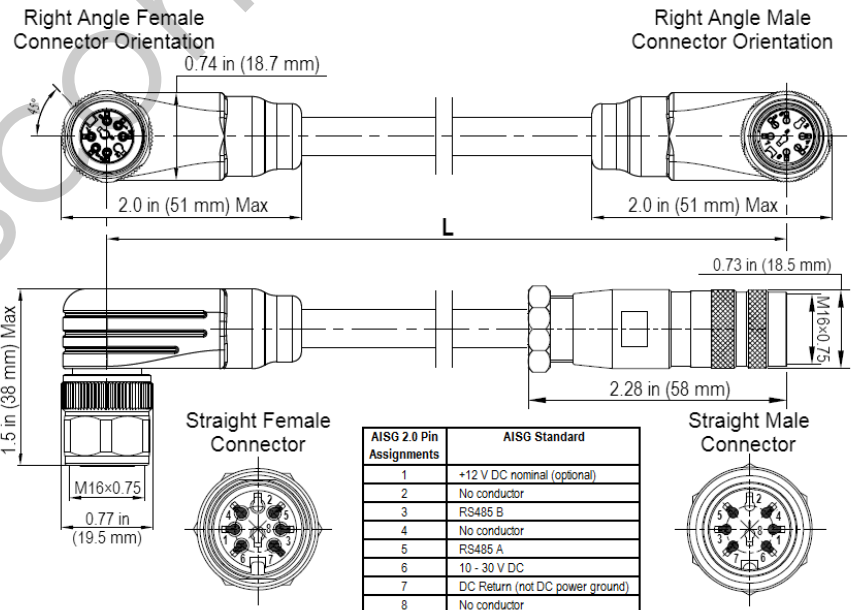
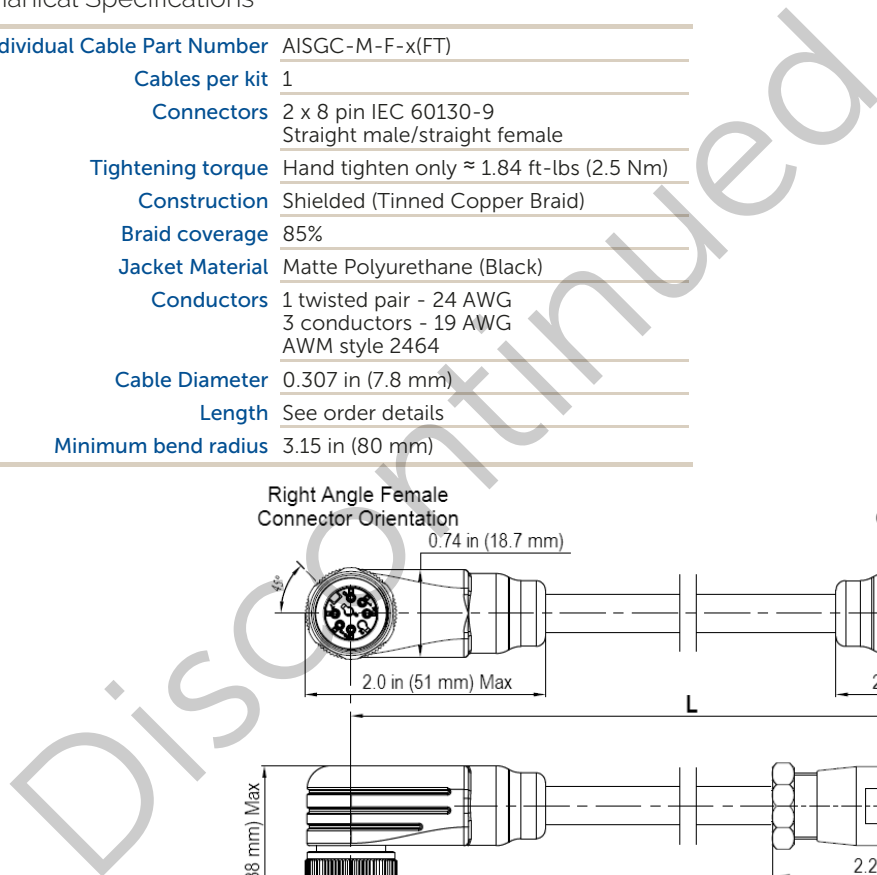

AISG 2.0 Pin Assignments	AISG Standard
1	+12 V DC nominal (optional)
2	No conductor
3	RS485 B
4	No conductor
5	RS485 A
6	10 - 30 V DC
7	DC Return (not DC power ground)
8	No conductor

AISG-Male to AISG-Female Jumper Cable



Antennas

ACCESSORIES

AISG Cable

AISGC-M-F-xFT

Environmental Specifications

Individual Cable Part Number	AISGC-M-F-xFT
Temperature Range	-40° to 80° C
Flammability	UL 1581 VW-1
Ingress Protection	IEC 60529:2001, IP67

Discontinued



Antennas

STANDARDS & CERTIFICATIONS

Hybrid Multiband Beamforming Antenna

12HBF4R-BUH8NA

Standards & Compliance

Safety	EN 60950-1, UL 60950-1
Emission	EN 55022
Immunity	EN 55024
Environmental	IEC 60068-2-1, IEC 60068-2-2, IEC 60068-2-5, IEC 60068-2-6, IEC-60068-2-11, IEC 60068-2-14, IEC 60068-2-18, IEC 60068-2-27, IEC 60068-2-29, IEC 60068-02-30, IEC 60068-2-52, IEC 60068-2-64, GR-63-CORE 4.3.1, EN 60529, IP 24

Certifications

Antenna Interface Standards Group (AISG), Federal Communication Commission (FCC) Part 15 Class B, CE, CSA US, ISO 9001

