

- Six foot (1.8 m) TriBand, twelve port antenna with a 65° azimuth beamwidth covering 698-960 MHz and 1695-2690 MHz frequencies
- Eight wide high band ports covering 1695-2690 MHz and four wide low band ports covering 698-960 MHz in a single antenna enclosure
- Full Spectrum Compliance 698-960 MHz / 1695-2690 MHz
- Innovative Low and High Band Array configuration allows for 4T4R (4x4 MIMO) on Low Band and Dual 4T4R (4x4 MIMO) High Band Arrays, using full length arrays (non stacked), all in a 21.0" (534mm) width enclosure, an Industry First
- LTE Optimized FBR and SPR performance, providing for an efficient use of valuable radio capacity
- LTE Optimized Boresight and Sector XPD and USL performance, essential for LTE Performance
- Exceeds minimum PIM performance requirements
- Equipped with new 4.3-10 connector, which is 40% smaller than traditional 7/16 DIN connector
- Equipped with 3 field replaceable, integrated AISG 2.0 compliant Remote Electrical Tilt (RET) Controllers (Type 1 External)

Overview

The CCI 12-Port TriBand array is a twelve port antenna, with eight wide high band ports covering 1695-2690 MHz and four wide low band ports covering 698-960 MHz. The antenna provides the capability to deploy Dual 4x4 Multiple-input Multiple-output (MIMO) in the high band and 4X4 MIMO across low band ports. The CCI 12-Port high band ports have independent tilt control between left and right antenna arrays.

In this three RET configuration, the 1st RET is dedicated for the four Low Band ports. The 2nd RET is dedicated for the four Left High Band ports and the 3rd RET is dedicated for the four Right High Band ports. This RET arrangement allows for complete flexibility in coverage control between left and right high band antenna arrays.

CCI antennas are designed and produced to ISO 9001 certification standards for reliability and quality in our state-of-the-art manufacturing facilities.

Applications

- Dual 4x4 MIMO for the High Band and 4X4 MIMO Low Band ports
- Ready for Network Standardization on 4.3-10 DIN connectors
- With CCI's TriBand antennas, wireless providers can connect multiple platforms to a single antenna, reducing tower load, lease expense, deployment time and installation costs



TriBand Twelve-Port Antenna

TPA65R-KE6D

SPECIFICATIONS

Electrical

Ports	4 × Low Band Ports for 698-960 MHz			
Frequency Range	698-806 MHz	790-862 MHz	824-896 MHz	880-960 MHz
Gain	14.5 dBi	14.8 dBi	15.1 dBi	15.2 dBi
Azimuth Beamwidth (-3dB)	73°	67°	63°	56°
Elevation Beamwidth (-3dB)	12.8°	11.6°	11.1°	10.4°
Electrical Downtilt	2° to 12°	2° to 12°	2° to 12°	2° to 12°
Elevation Sidelobes (1st Upper)	< -17 dB	< -18 dB	< -18 dB	< -17 dB
Front-to-Back Ratio @180°	> 32 dB	> 35 dB	> 35 dB	> 35 dB
Cross-Polar Discrimination at Peak	> 25 dB	> 25 dB	> 25 dB	> 24 dB
Cross-Polar Port-to-Port Isolation	> 25 dB	> 25 dB	> 25 dB	> 25 dB
Voltage Standing Wave Ratio (VSWR)	< 1.5:1	< 1.5:1	< 1.5:1	< 1.5:1
Passive Intermodulation (2x20W)	≤ -153 dBc	≤ -153 dBc	≤ -153 dBc	≤ -153 dBc
Input Power Continuous Wave (CW)	500 watts	500 watts	500 watts	500 watts
Polarization	Dual Linear 45°	Dual Linear 45°	Dual Linear 45°	Dual Linear 45°
Input Impedance	50 ohms	50 ohms	50 ohms	50 ohms
Lightning Protection	DC Ground	DC Ground	DC Ground	DC Ground

BASTA Electrical Specifications				
Frequency Range	698-806 MHz	790-862 MHz	824-896 MHz	880-960 MHz
Gain over all Tilts (dBi)	13.6	14.1	14.4	14.7
Gain over all Tilts Tolerance (dB)	0.6	0.5	0.5	0.5
Gain at Low-Tilt (dBi)	13.9	14.3	14.6	14.9
Gain at Mid-Tilt (dBi)	13.6	14.2	14.5	14.8
Gain at High-Tilt (dBi)	13.3	13.9	14.2	14.3
Azimuth Beamwidth Tolerance (°)	9.9	5.9	7.7	7.8
Elevation Beamwidth Tolerance (°)	1.1	0.8	0.8	0.6
Electrical Downtilt Deviation (°)	0.7	0.4	0.4	0.5
First Upper Sidelobe Suppression (dB)	14.4	15.2	14.4	12.7
Upper Sidelobe Suppression Peak to 20°(dB)	15.6	16.0	15.4	13.8
Front-to-Back Ratio over ±20° (dB)	22.4	26.2	26.8	26.9
Cross-polar Discrimination at ±60° (dB)	11.2	11.7	12.1	10.5

* Electrical specifications follow document "Recommendation on Base Station Antenna Standards" (BASTA) V9.6. All specifications are subject to change without notice.



SPECIFICATIONS

TriBand Twelve-Port Antenna

TPA65R-KE6D

Electrical

Ports	8 x High Band Ports for 1695-2690 MHz				
Frequency Range	1695-1880 MHz	1850-1990 MHz	1920-2180 MHz	2300-2400 MHz	2496-2690 MHz
Gain	17.8 dBi	18.1 dBi	18.4 dBi	18.0 dBi	18.4 dBi
Azimuth Beamwidth (-3dB)	70°	66°	66°	60°	57°
Elevation Beamwidth (-3dB)	5.7°	5.2°	4.8°	4.0°	3.7°
Electrical Downtilt	0° to 8°	0° to 8°	0° to 8°	0° to 8°	0° to 8°
Elevation Sidelobes (1st Upper)	< -16 dB	< -17 dB	< -17 dB	< -17 dB	< -18 dB
Front-to-Back Ratio @180°	> 35 dB	> 35 dB	> 35 dB	> 35 dB	> 35 dB
Cross-Polar Discrimination at Peak	> 19 dB	> 18 dB	> 19 dB	> 20 dB	> 20 dB
Cross-Polar Port-to-Port Isolation	> 25 dB	> 25 dB	> 25 dB	> 25 dB	> 25 dB
Voltage Standing Wave Ratio (VSWR)	< 1.5:1	< 1.5:1	< 1.5:1	< 1.5:1	< 1.5:1
Passive Intermodulation (2x20W)	≤ -153 dBc	≤ -153 dBc	≤ -153 dBc	≤ -153 dBc	≤ -153 dBc
Input Power Continuous Wave (CW)	300 watts	300 watts	300 watts	300 watts	300 watts
Polarization	Dual Linear 45°	Dual Linear 45°	Dual Linear 45°	Dual Linear 45°	Dual Linear 45°
Input Impedance	50 ohms	50 ohms	50 ohms	50 ohms	50 ohms
Lightning Protection	DC Ground	DC Ground	DC Ground	DC Ground	DC Ground

BASTA Electrical Specifications					
Frequency Range	1695-1880 MHz	1850-1990 MHz	1920-2180 MHz	2300-2400 MHz	2496-2690 MHz
Gain over all Tilts (dBi)	16.6	17.0	17.3	16.9	17.6
Gain over all Tilts Tolerance (dB)	0.8	0.9	0.9	0.9	0.8
Gain at Low-Tilt (dBi)	16.5	16.6	16.9	16.5	17.2
Gain at Mid-Tilt (dBi)	16.7	17.1	17.5	17.2	17.8
Gain at High-Tilt (dBi)	16.7	17.3	17.6	17.0	17.7
Azimuth Beamwidth Tolerance (°)	8.3	7.2	6.8	10.4	5.6
Elevation Beamwidth Tolerance (°)	0.5	0.3	0.5	0.2	0.2
Electrical Downtilt Deviation (°)	1.1	1.1	1.1	1.2	1.2
First Upper Sidelobes Suppression (dB)	12.2	12.8	13.3	14.1	14.5
Upper Sidelobe Suppression Peak to 20°(dB)	11.5	12.1	11.8	9.9	10.6
Front-to-Back Ratio over ±20° (dB)	26.9	28.2	28.4	27.7	29.2
Cross-polar Discrimination at ±60° (dB)	12.4	10.4	10.8	8.5	9.8

* Electrical specifications follow document "Recommendation on Base Station Antenna Standards" (BASTA) V9.6. All specifications are subject to change without notice.

Mechanical

Dimensions (LxWxD)	71.2x20.7x7.7 in (1808x525x197 mm)
Survival Wind Speed	> 150 mph (> 241 kph)
Front Wind Load	325 lbs (1446 N) @ 100 mph (161 kph)
Side Wind Load	144 lbs (642 N) @ 100 mph (161 kph)
Equivalent Flat Plate Area	12.9 ft ² (1.2 m ²)
Weight *	68.3 lbs (31.0 kg)
Packaging Dimensions (LxWxD)	81.4x25.2x13.9 in (2067x641x354 mm)
Packaged Weight ~	116.8 lbs (53.0 kg)
Connector	12 x 4.3-10 female
Mounting Pole	2 to 5 in (5 to 12 cm)

* Weight excludes mounting



SPECIFICATIONS

TriBand Twelve-Port Antenna

TPA65R-KE6D

Mechanical

Bottom View

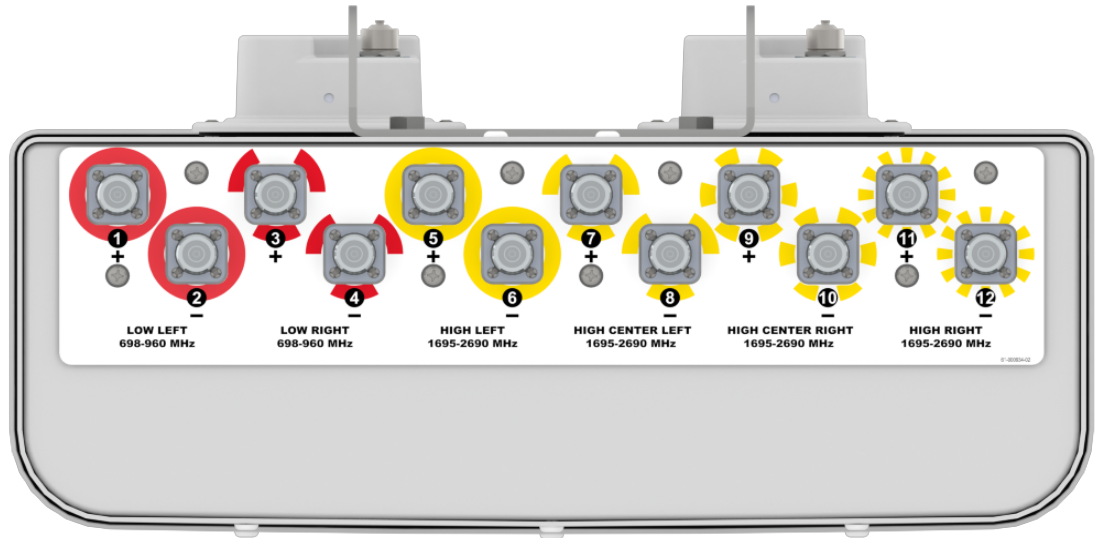

Connector Spacing

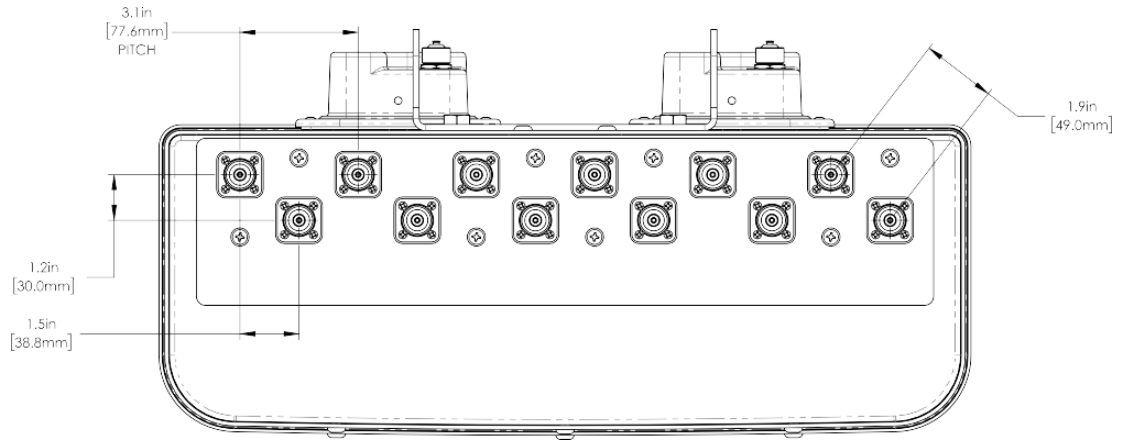

TriBand Twelve-Port Antenna

TPA65R-KE6D

SPECIFICATIONS

Mechanical

RET to Element Configuration TPA65R-KE6DA Element and RET configuration (Type 1 External RET)

**Top of antenna
Viewed from rear**

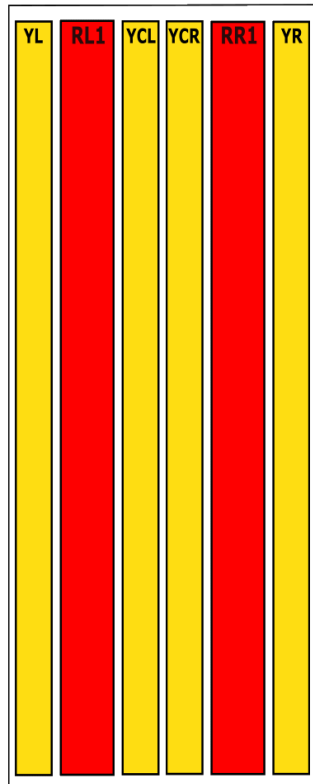

Mechanical

**RET placement
as viewed from rear
of antenna**

Top of antenna

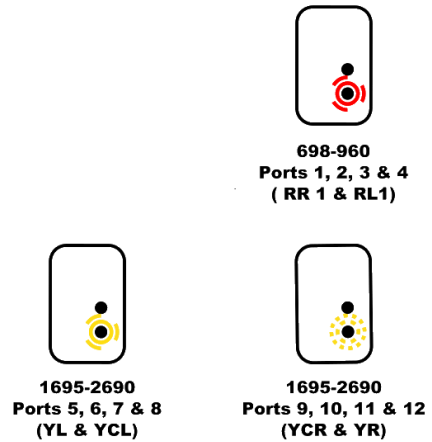

Array	Ports	Freq (MHz)	Ports controlled by common RET
RL1	1, 2	698-960	1, 2, 3, 4
RR1	3, 4	698-960	
YL	5, 6	1695-2690	5, 6, 7, 8
YCL	7, 8	1695-2690	
YCR	9,10	1695-2690	9, 10, 11, 12
YR	11,12	1695-2690	



TriBand Twelve-Port Antenna

TPA65R-KE6D

Typical Antenna Patterns

For detailed information on additional antenna patterns, contact customer support at support@cciproducts.com

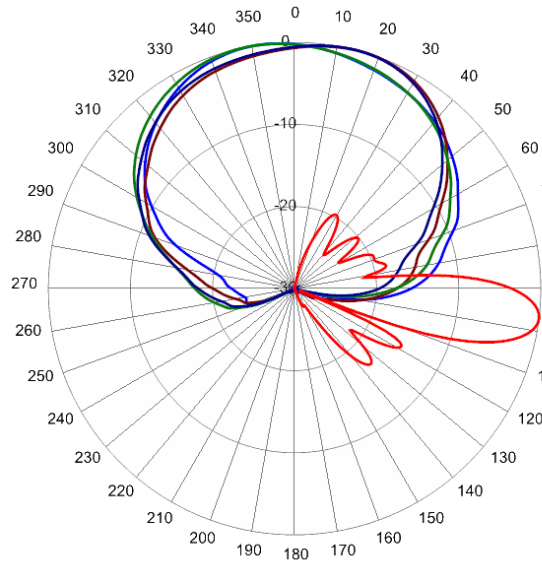

734 MHz Azimuth with Elevation 7°

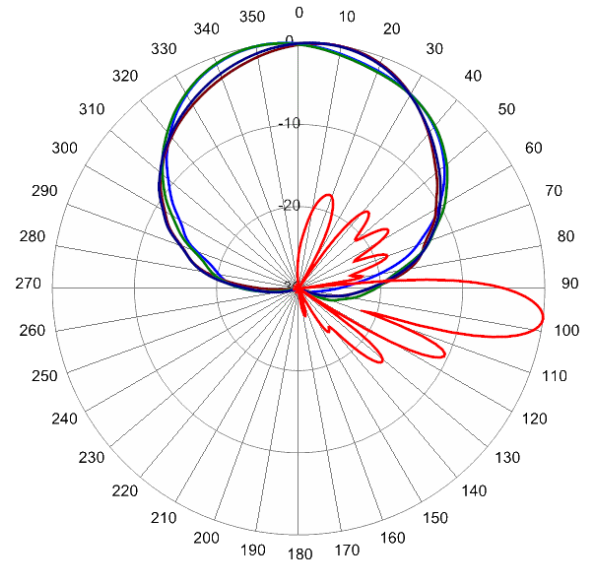

880 MHz Azimuth with Elevation 7°

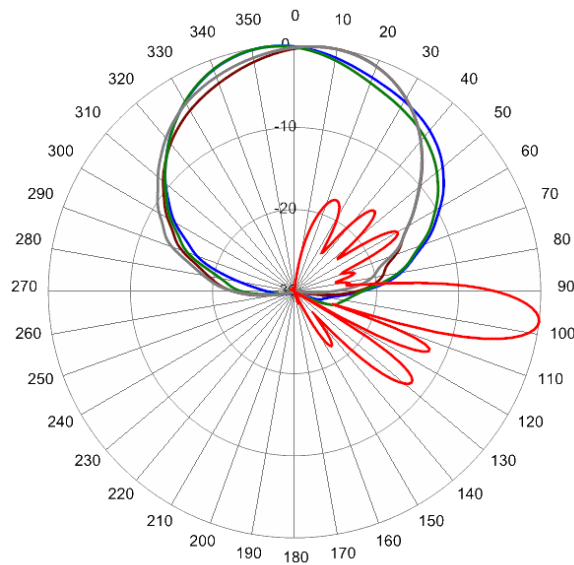

925 MHz Azimuth with Elevation 7°



TriBand Twelve-Port Antenna

TPA65R-KE6D

Typical Antenna Patterns

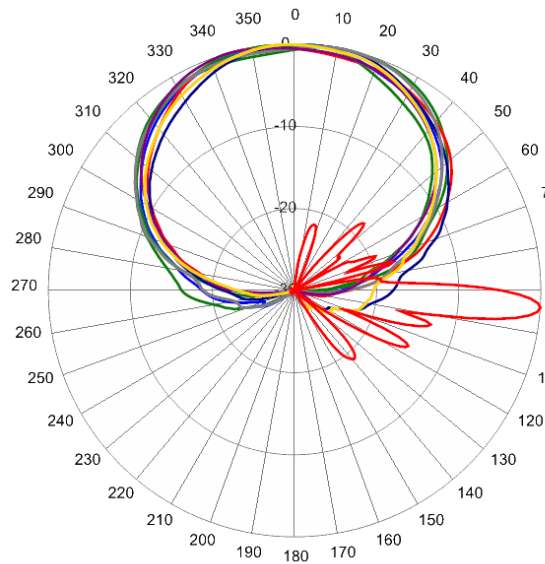

1720 MHz Azimuth with Elevation 4°

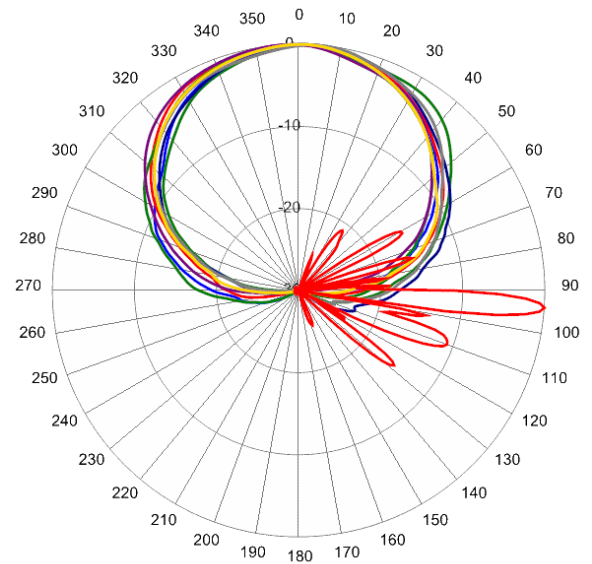

2155 MHz Azimuth with Elevation 4°

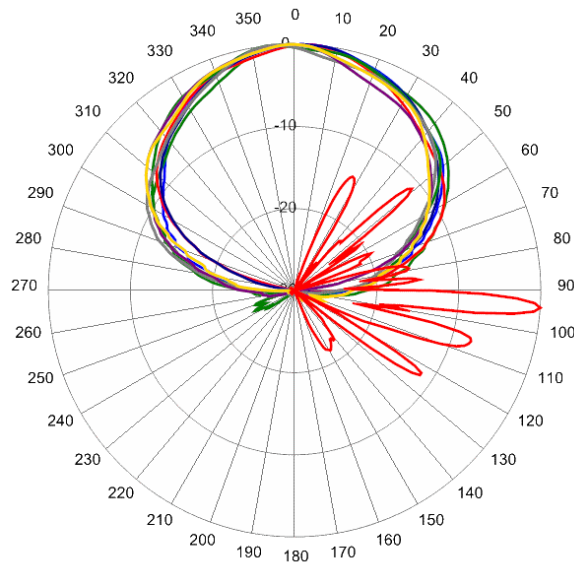

2500 MHz Azimuth with Elevation 4°



ORDERING

TriBand Twelve-Port Antenna

TPA65R-KE6D

Parts & Accessories

TPA65R-KE6DA-K	Six foot (1.8 m) TriBand antenna with 65° azimuth beamwidth, 4.3-10 female connectors, 3 factory installed BSA-RET200 RET actuators and MBK-01 mounting bracket
MBK-01	Mounting bracket kit (top and bottom) with 0° to 10° mechanical tilt adjustment
BSA-RET200	Remote electrical tilt actuator
DPA-CBK-AG-RRU	RRU AISG cable kit for three RET antenna
DPA-CBK-RA-AG-RRU	RRU AISG right angle cable kit for three RET antenna



Mounting Bracket Kit

MBK-01

Mechanical

Weight	12.6 lbs (5.7 kg)
Hinge Pitch	47.25 in (1200 mm)
Mounting Pole Dimension	2 to 5 in (5 to 12 cm)
Fastener Size	M12
Installation Torque	40 ft·lb (54 N·m)
Mechanical Tilt Adjustment	0° - 10°

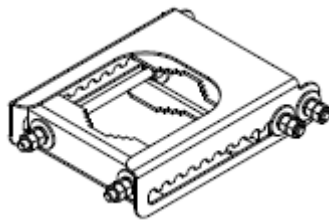

MBK-01 Top Adjustable Bracket

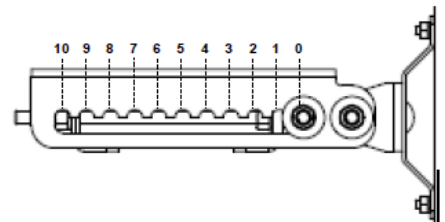

MBK-01 Top Adjustable Bracket Side View

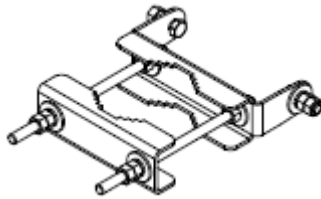

MBK-01 Bottom Fixed Bracket



Remote Electrical Tilt Actuator (RET)

BSA-RET200

General Specifications

Part Number	BSA-RET200
Protocols	AISG 2.0
RET Type	Type 1
Adjustment Cycles	>10,000 cycles
Tilt Accuracy	±0.1°
Temperature Range	-40° C to 70° C

Electrical

Data Interface Signal	DC
Input Voltage	10-30 Vdc
Current Consumption Tilt	120 mA at $V_{in}=24$
Current Consumption Idle	55 mA at $V_{in}=24$
Hardware Interface	AISG-RS 485 A/B
Input Connector	Male 1 × 8 pin Daisy Chain
Output Connector	Female 1 × 8 pin Daisy Chain

Mechanical

Dimensions (LxWxD)	8.0x5.0x2.0 in. (213x135x51 mm)
Housing	ASA/ABS/Aluminum
Weight	1.7 lbs (0.75 kg)

ASA= Acrylic Styrene Acrylonitrile
ABS=Acrylonitrile Butadiene Styrene

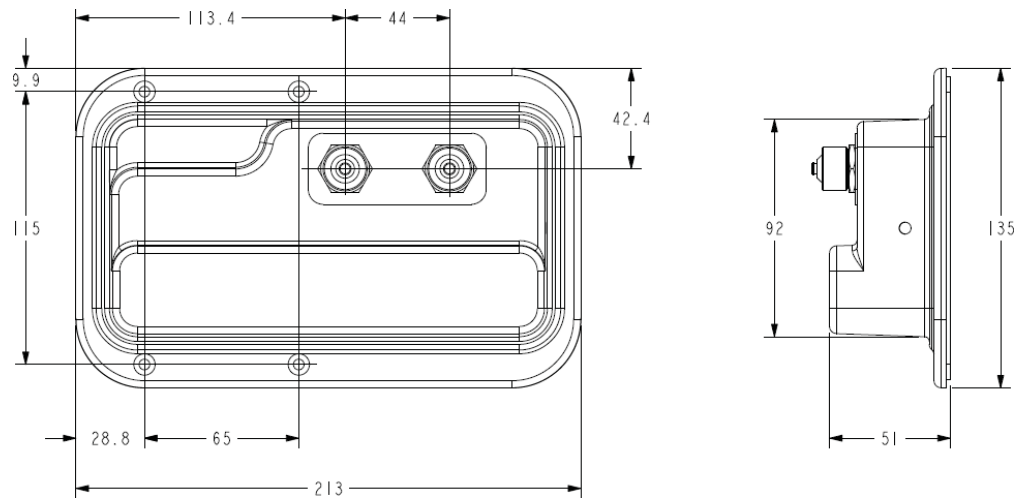



AISG Cable Kit

Electrical/Mechanical/Environmental Specifications

	RET to RET Cables	RRU to Antenna Cables
Individual Cable Part Number	AISGC-M-F-27	AISGC-M-F-10FT
Cable style	UL2464	
Protocol	AISG 1.1 and AISG 2.0	
Maximum voltage	300 V	
Rated current	5 A at 104° F (40° C)	
Temperature Range	-40° to 80° C	
Flammability	UL 1581 VW-1	
Ingress Protection	IEC 60529:2001, IP67	
Tightening torque	Hand tighten only ≈ 1.84 ft-lbs (2.5 N·m)	
Construction	Shielded (Tinned Copper Braid)	
Braid coverage	85%	
Jacket Material	Matte Polyurethane (Black)	
Conductors	1 twisted pair - 24 AWG 3 conductors - 19 AWG AWM style 2464	
Cable Diameter	0.307 in (7.8 mm)	
Minimum bend radius	3.9 in (100 mm)	
Connectors	2 x 8 pin IEC 60130-9 Straight male/straight female	
Length	27 in (686 mm)	120 in (3048 mm)
Weight	0.33 lbs (0.15 kg)	0.69 lbs (0.31 kg)
Cables per kit	2	2

Mechanical Specifications

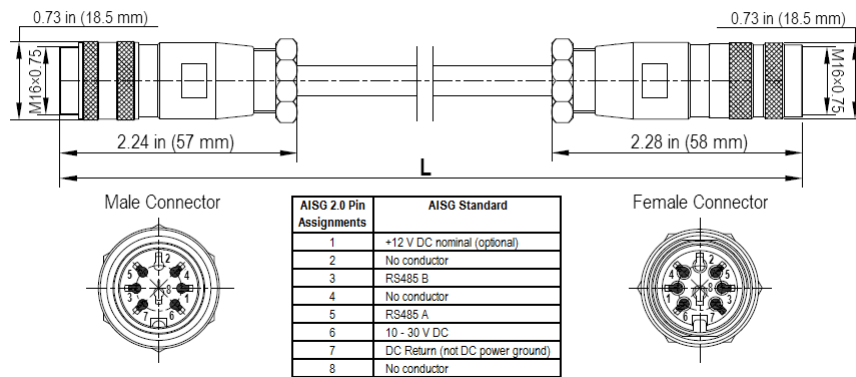

AISG-Male to AISG-Female Jumper Cable

Electrical/Mechanical/Environmental Specifications

	RET to RET Cables	RRU to Antenna Cables
Individual Cable Part Number	AISGC-MRA-FRA-36	AISGC-M-FRA-10FT
Cable style	UL2464	
Protocol	AISG 1.1 and AISG 2.0	
Maximum voltage	300 V	
Rated current	5 A at 104° F (40° C)	
Temperature Range	-40° to 80° C	
Flammability	UL 1581 VW-1	
Ingress Protection	IEC 60529:2001, IP67	
Tightening torque	Hand tighten only ≈ 1.84 ft-lbs (2.5 N·m)	
Construction	Shielded (Tinned Copper Braid)	
Braid coverage	85%	
Jacket Material	Matte Polyurethane (Black)	
Conductors	1 twisted pair - 24 AWG 3 conductors - 19 AWG AWM style 2464	
Cable Diameter	0.307 in (7.8 mm)	
Minimum bend radius	3.9 in (100 mm)	
Connectors	2 x 8 pin IEC 60130-9 Right angle male/right angle female	2 x 8 pin IEC 60130-9 Straight male/right angle female
Length	36 in (914 mm)	120 in (3048 mm)
Weight	0.23 lbs (0.10 kg)	0.77 lbs (0.35 kg)
Cables per kit	2	2

Mechanical Specifications

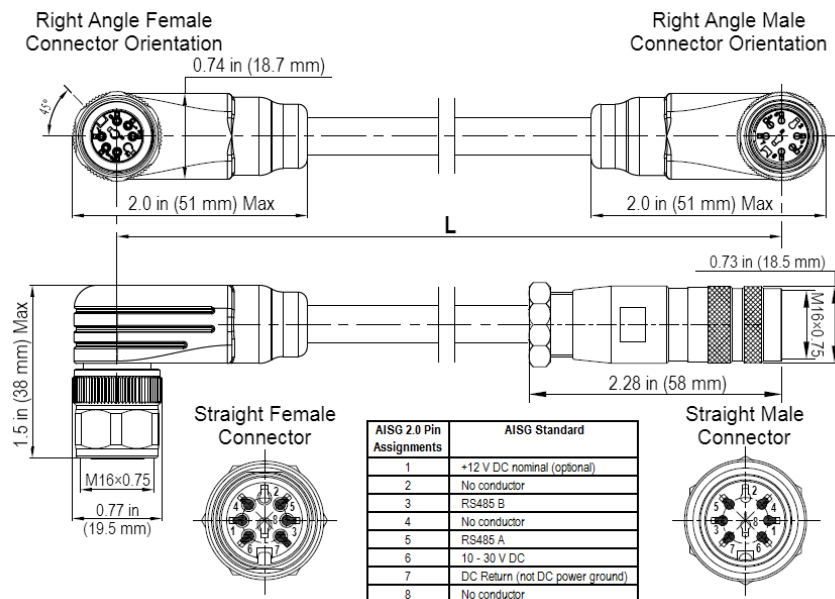

Right Angle to Right Angle and Right Angle to Straight Jumper Cable



STANDARDS & CERTIFICATIONS

TriBand Twelve-Port Antenna

TPA65R-KE6D

Standards & Compliance

Safety	EN 60950-1, UL 60950-1
Emission	EN 55022
Immunity	EN 55024
Environmental	IEC 60068-2-1, IEC 60068-2-2, IEC 60068-2-5, IEC 60068-2-6, IEC-60068-2-11, IEC 60068-2-14, IEC 60068-2-18, IEC 60068-2-27, IEC 60068-2-29, IEC 60068-02-30, IEC 60068-2-52, IEC 60068-2-64, GR-63-CORE 4.3.1, EN 60529, IP 24

Certifications

Antenna Interface Standards Group (AISG), Federal Communication Commission (FCC) Part 15 Class B, CE, CSA US, ISO 9001

