

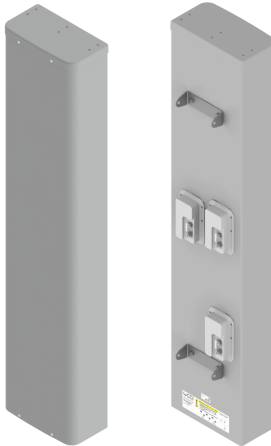

DATA SHEET

TriBand Antenna

HPA45R-KE6A



- Six foot (1.8 m), TriBand, six port antenna with a 45° azimuth beamwidth covering 698-960 MHz and 1695-2690 MHz frequencies
- Four wide high band ports covering 1695-2690 MHz and two wide low band ports covering 698-960 MHz in a single antenna
- New enclosure with <15.4" (391 mm) width, narrowest enclosure in the industry for a 45° TriBand Antenna
- Full Spectrum Compliance 698-960 MHz / 1695-2690 MHz
- LTE Optimized FBR and SPR performance, providing for an efficient use of valuable radio capacity
- LTE Optimized Boresight and Sector XPD and USL performance, essential for LTE Performance
- Exceeds minimum PIM performance requirements
- Comes with 4.3-10 connector, which is 40% smaller than traditional 7/16 DIN connector
- Ordering options for 2 or 3 field replaceable, integrated AISG 2.0 compliant Remote Electrical Tilt (RET) controllers

Overview

The CCI TriBand Antenna is a six port antenna, with four wide high band ports covering 1695-2690 MHz and two wide low band ports covering 698-960 MHz. The CCI TriBand Antenna provides the capability to deploy 4x4 Multiple-input Multiple-output (MIMO) in the high band and 2x2 Multiple-input Multiple-output in the low band. The CCI TriBand antenna allows separate tilt control between the low band ports and high band ports. With the use of three (3) RET controllers, the paired high band ports can be tilted independently, enabling maximum flexibility in network deployment.

CCI antennas are designed and produced to ISO 9001 certification standards for reliability and quality in our state-of-the-art manufacturing facilities.

Applications

- 4x4 MIMO for the high band and 2x2 MIMO for the low band
- Ready for Network Standardization on 4.3-10 connectors
- With CCI's TriBand antennas, wireless providers can connect multiple platforms to a single antenna, reducing tower load, lease expense, deployment time and installation costs



TriBand Antenna

HPA45R-KE6A

SPECIFICATIONS

Electrical

Ports	2 x Low Band Ports for 698-960 MHz			
Frequency Range	698-806 MHz	790-862 MHz	824-896 MHz	880-960 MHz
Gain	15.6 dBi	16.2 dBi	16.6 dBi	16.9 dBi
Azimuth Beamwidth (-3dB)	51°	50°	47°	44°
Elevation Beamwidth (-3dB)	12.1°	10.9°	10.5°	9.9°
Electrical Downtilt	2° to 12°	2° to 12°	2° to 12°	2° to 12°
Elevation Sidelobes (1st Upper)	< -17 dB	< -18 dB	< -18 dB	< -18 dB
Front-to-Back Ratio @180°	> 28 dB	> 30 dB	> 30 dB	> 28 dB
Cross-Polar Discrimination at Peak	> 20 dB	> 22 dB	> 22 dB	> 20 dB
Cross-Polar Port-to-Port Isolation	> 25 dB	> 25 dB	> 25 dB	> 25 dB
Voltage Standing Wave Ratio (VSWR)	< 1.5:1	< 1.5:1	< 1.5:1	< 1.5:1
Passive Intermodulation (2x20W)	≤ -150 dBc	≤ -150 dBc	≤ -150 dBc	≤ -150 dBc
Input Power Continuous Wave (CW)	500 watts	500 watts	500 watts	500 watts
Polarization	Dual Linear 45°	Dual Linear 45°	Dual Linear 45°	Dual Linear 45°
Input Impedance	50 ohms	50 ohms	50 ohms	50 ohms
Lightning Protection	DC Ground	DC Ground	DC Ground	DC Ground

BASTA Electrical Specifications*				
Frequency Range	698-806 MHz	790-862 MHz	824-896 MHz	880-960 MHz
Gain over all Tilts (dBi)	15.3	15.7	16.1	16.4
Gain over all Tilts Tolerance (dB)	0.3	0.5	0.5	0.5
Gain at Low-Tilt (dBi)	15.5	15.8	16.2	16.6
Gain at Mid-Tilt (dBi)	15.3	15.8	16.1	16.5
Gain at High-Tilt (dBi)	15.0	15.6	15.9	16.0
Azimuth Beamwidth Tolerance (°)	0.8	2.4	3.0	1.7
Elevation Beamwidth Tolerance (°)	0.9	0.6	0.5	0.5
Electrical Downtilt Deviation (°)	0.9	0.8	0.8	0.9
First Upper Sidelobe Suppression (dB)	13.3	15.1	15.8	15.7
Upper Sidelobe Suppression Peak to 20° (dB)	14.6	15.4	16.2	15.9
Front-to-Back Ratio over ±20° (dB)	22.7	24.1	23.4	22.1
Cross-polar Discrimination at 3 dB (dB)	18.2	19.0	19.2	17.0

* Electrical specifications follow document "Recommendation on Base Station Antenna Standards" (BASTA) V9.6. All specifications are subject to change without notice.



TriBand Antenna

HPA45R-KE6A

SPECIFICATIONS

Ports	4 x High Band Ports for 1695-2690 MHz				
Frequency Range	1695-1880 MHz	1850-1990 MHz	1920-2180 MHz	2300-2400 MHz	2496-2690 MHz
Gain	18.9 dBi	19.3 dBi	19.7 dBi	20.0 dBi	20.5 dBi
Azimuth Beamwidth (-3dB)	44°	43°	42°	43°	36°
Elevation Beamwidth (-3dB)	5.3°	4.9°	4.6°	4.1°	3.7°
Electrical Downtilt	2° to 10°	2° to 10°	2° to 10°	2° to 10°	2° to 10°
Elevation Sidelobes (1st Upper)	< -16 dB	< -17 dB	< -17 dB	< -18 dB	< -18 dB
Front-to-Back Ratio @180°	> 30 dB	> 32 dB	> 32 dB	> 35 dB	> 35 dB
Cross-Polar Discrimination at Peak	> 20 dB	> 20 dB	> 23 dB	> 25 dB	> 23 dB
Cross-Polar Port-to-Port Isolation	> 25 dB	> 25 dB	> 25 dB	> 25 dB	> 25 dB
Voltage Standing Wave Ratio (VSWR)	< 1.5:1	< 1.5:1	< 1.5:1	< 1.5:1	< 1.5:1
Passive Intermodulation (2x20W)	≤ -150 dBc	≤ -150 dBc	≤ -150 dBc	≤ -150 dBc	≤ -150 dBc
Input Power Continuous Wave (CW)	300 watts	300 watts	300 watts	300 watts	300 watts
Polarization	Dual Linear 45°	Dual Linear 45°	Dual Linear 45°	Dual Linear 45°	Dual Linear 45°
Input Impedance	50 ohms	50 ohms	50 ohms	50 ohms	50 ohms
Lightning Protection	DC Ground	DC Ground	DC Ground	DC Ground	DC Ground

BASTA Electrical Specifications*	1695-1880 MHz	1850-1990 MHz	1920-2180 MHz	2300-2400 MHz	2496-2690 MHz
Frequency Range	1695-1880 MHz	1850-1990 MHz	1920-2180 MHz	2300-2400 MHz	2496-2690 MHz
Gain over all Tilts (dBi)	18.0	18.7	19.0	19.2	19.7
Gain over all Tilts Tolerance (dB)	0.6	0.5	0.5	0.5	0.6
Gain at Low-Tilt (dBi)	17.9	18.5	18.8	19.0	19.7
Gain at Mid-Tilt (dBi)	18.1	18.8	19.2	19.4	19.9
Gain at High-Tilt (dBi)	18.0	18.6	19.0	19.1	19.3
Azimuth Beamwidth Tolerance (°)	2.9	3.2	3.6	3.6	3.9
Elevation Beamwidth Tolerance (°)	0.3	0.3	0.3	0.2	0.3
Electrical Downtilt Deviation (°)	0.3	0.4	0.4	0.2	0.2
First Upper Sidelobes Suppression (dB)	13.6	13.8	13.6	15.1	14.6
Upper Sidelobe Suppression Peak to 20° (dB)	13.3	13.2	12.7	13.6	13.3
Front-to-Back Ratio over ±20° (dB)	19.2	20.9	21.8	26.4	28.0
Cross-polar Discrimination at 3 dB (dB)	15.7	16.7	17.1	19.0	18.5

* Electrical specifications follow document "Recommendation on Base Station Antenna Standards" (BASTA) V9.6. All specifications are subject to change without notice.

Mechanical

Dimensions (LxWxD)	72.0x15.4x8.2 in (1828x391x208 mm)
Survival Wind Speed	> 150 mph (> 241 kph)
Front Wind Load	255 lbs (1136 N) @ 100 mph (161 kph)
Side Wind Load	153 lbs (680 N) @ 100 mph (161 kph)
Equivalent Flat Plate Area	10.0 ft ² (0.9 m ²)
Weight *	63.9 lbs (29.0 kg)
RET Weight per RET	1.7 lbs (0.75 kg)
Connector	6 x 4.3-10 female
Mounting Pole	2 to 5 in (5 to 12 cm)

* Weight excludes mounting and RET



SPECIFICATIONS

TriBand Antenna

HPA45R-KE6A

Mechanical

Bottom View

HPA45R-KE6A

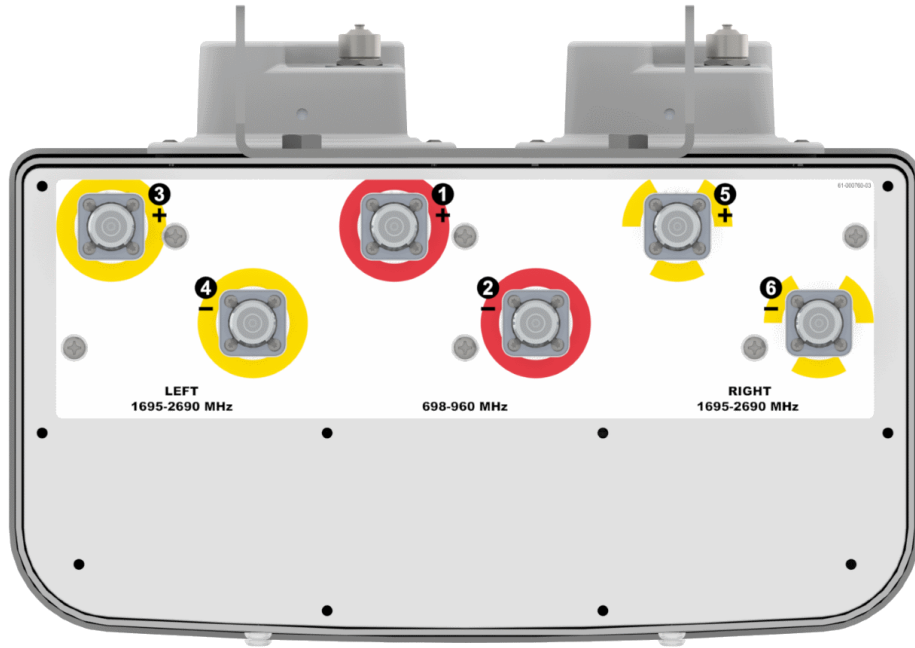

Connector Spacing Diagram

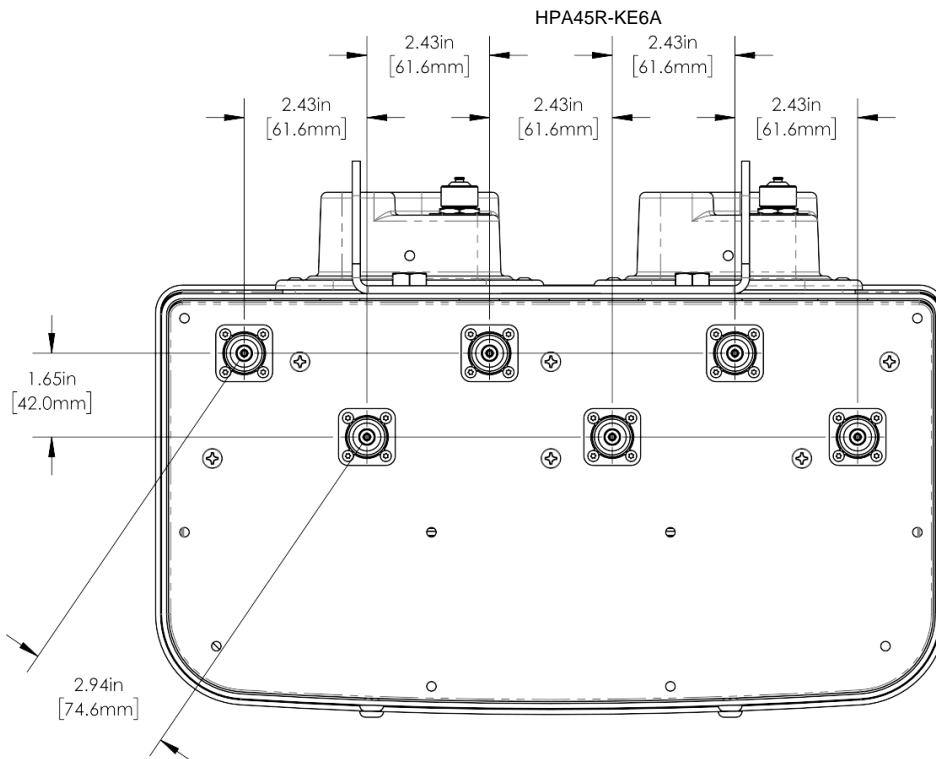

SPECIFICATIONS

Mechanical

RET to Element Configuration

HPA45R-KE6AA Element and RET configuration

**Top of antenna
Viewed from rear**

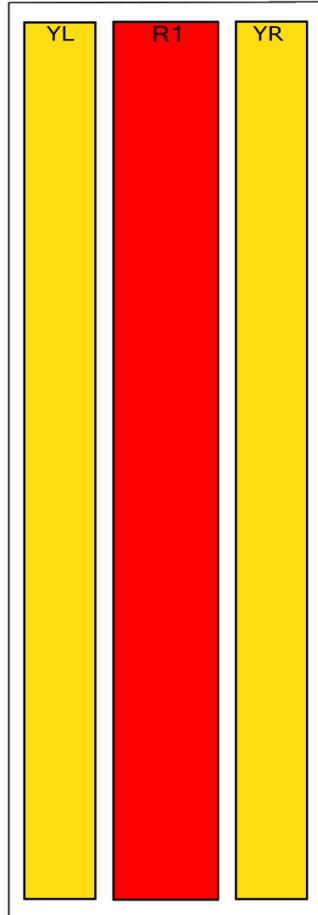

**RET placement
as view from rear
of antenna**

Top of antenna

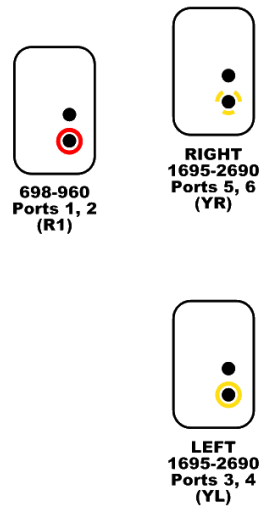

Array	Ports	Freq (MHz)	Ports controlled by common RET
R1	1, 2	698-960	1, 2
YL	3, 4	1695-2690	3, 4
YR	5, 6	1695-2690	5, 6



SPECIFICATIONS

Mechanical

RET to Element Configuration

HPA45R-KE6AB Element and RET configuration

**Top of antenna
Viewed from rear**

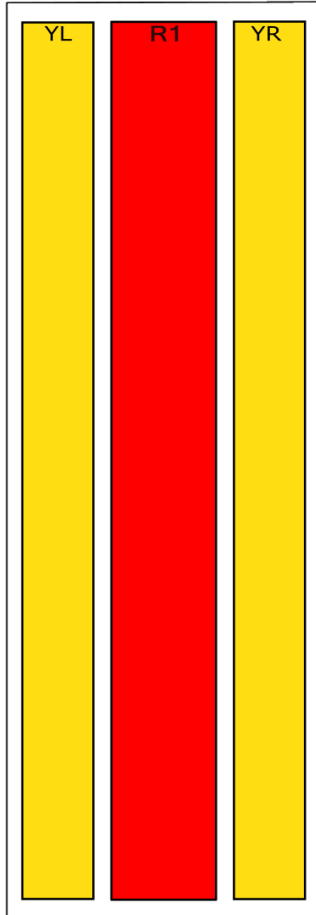

**RET placement
as view from rear
of antenna**

Top of antenna

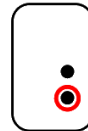

698-960
Ports 1, 2
(R1)

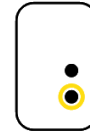

LEFT & RIGHT
1695-2690
Ports 3, 4, 5, 6
(YL & YR)

Array	Ports	Freq (MHz)	Ports controlled by common RET
R1	1, 2	698-960	1, 2
YL	3, 4	1695-2690	3, 4, 5, 6
YR	5, 6	1695-2690	



TriBand Antenna

HPA45R-KE6A

SPECIFICATIONS

Typical Antenna Patterns

For detailed information on additional antenna patterns, contact customer support at support@cciproducts.com

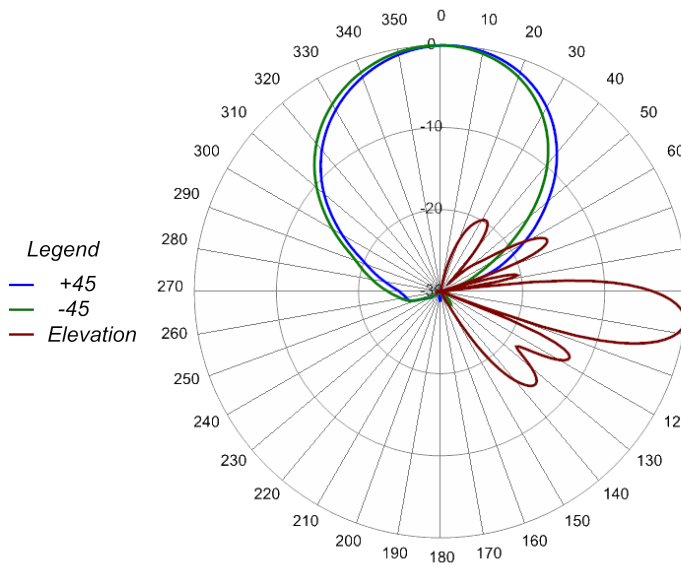

734 MHz Azimuth with Elevation 7°

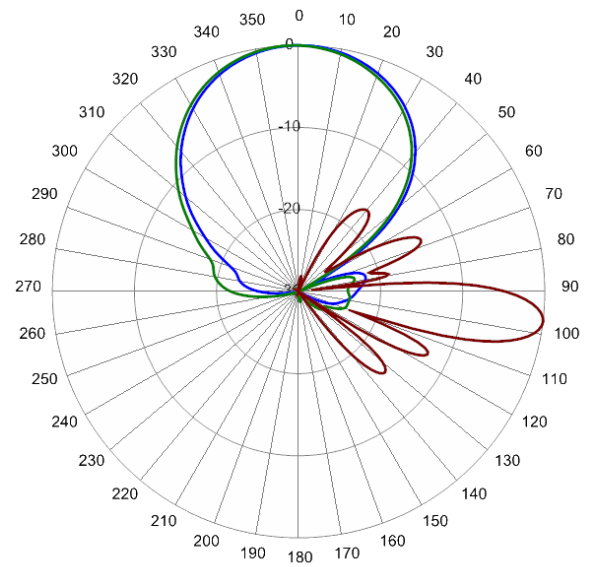

806 MHz Azimuth with Elevation 7°

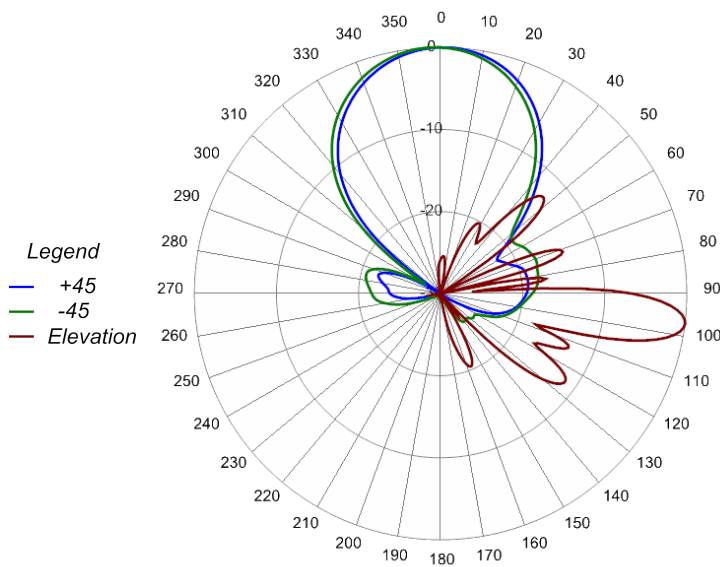

925 MHz Azimuth with Elevation 7°



TriBand Antenna

HPA45R-KE6A

SPECIFICATIONS

Typical Antenna Patterns

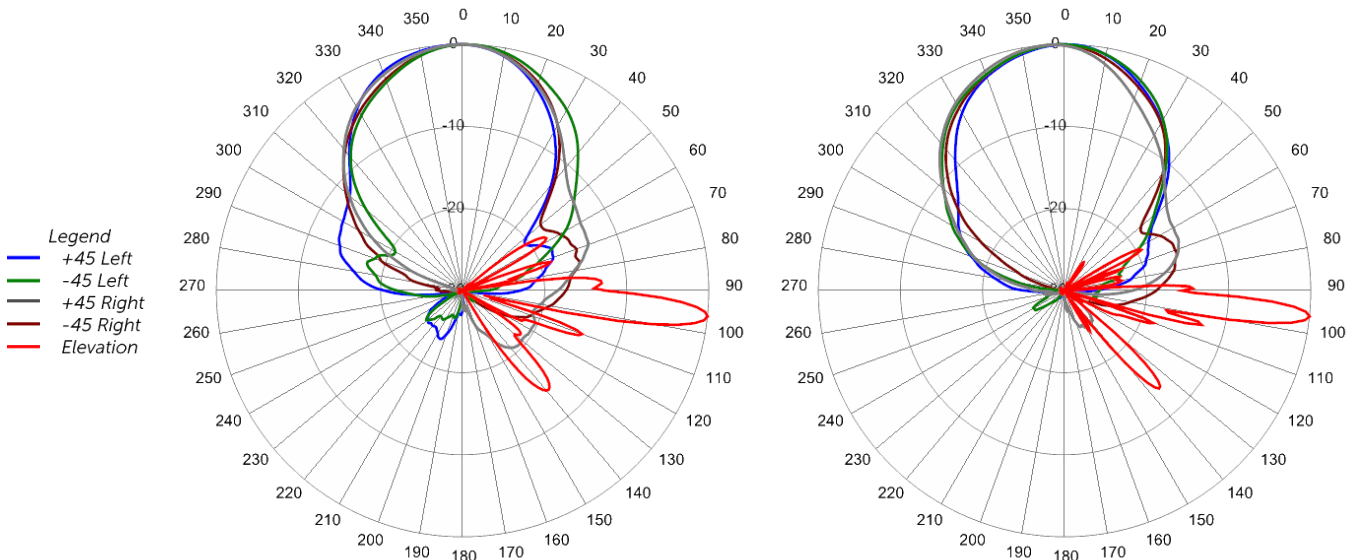

1780 MHz Azimuth with Elevation 6°

1960 MHz Azimuth with Elevation 6°

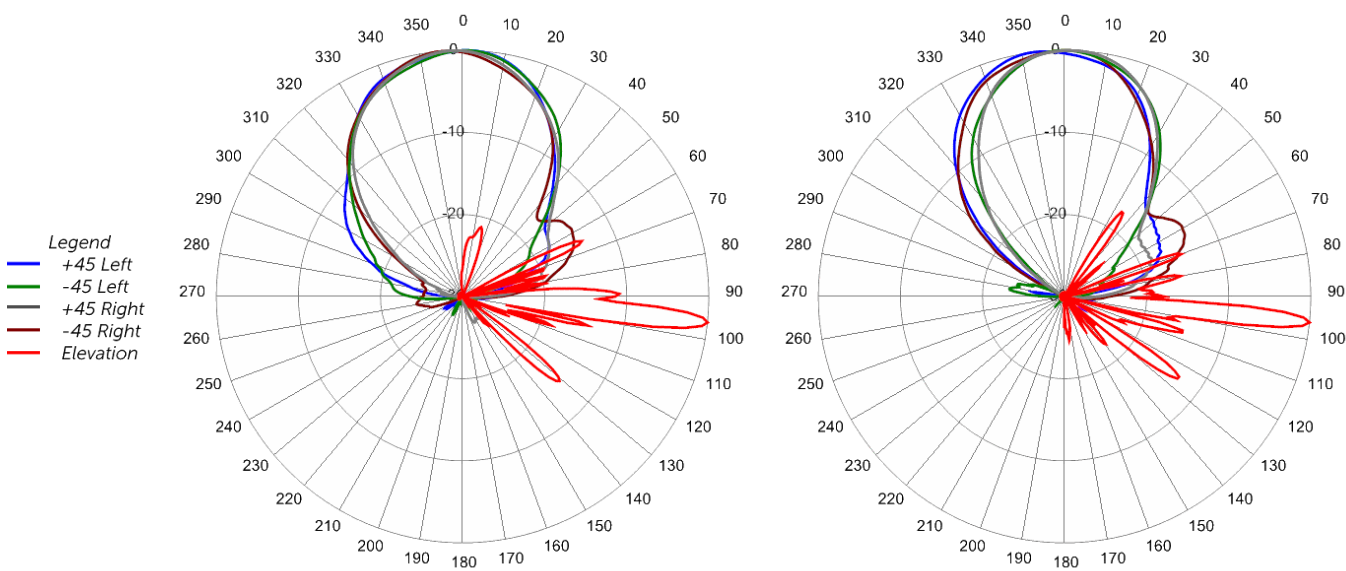

2155 MHz Azimuth with Elevation 6°

2500 MHz Azimuth with Elevation 6°



Parts & Accessories

HPA45R-KE6AA-K	Six foot (1.8 m) TriBand antenna with 45° azimuth beamwidth, 4.3-10 female connectors, 3 factory installed BSA-RET200 RET actuators (Type 1 External) and MBK-01 mounting bracket
HPA45R-KE6AB-K	Six foot (1.8 m) TriBand antenna with 45° azimuth beamwidth, 4.3-10 female connectors, 2 factory installed BSA-RET200 RET actuators (Type 1 External) and MBK-01 mounting bracket
MBK-01	Mounting bracket kit (top and bottom) with 0° to 10° mechanical tilt adjustment
BSA-RET200	Remote electrical tilt actuator
DPA-CBK-AG-RRU	TriBand antenna with 3 RET to RRU AISG cable kit
CBK-RA-AG-RRU-004	TriBand antenna with 3 RET to RRU AISG right angle cable kit
CBK-AG-RRU-001	TriBand antenna with 2 RET to RRU AISG cable kit
CBK-RA-AG-RRU-005	TriBand antenna with 2 RET to RRU AISG right angle cable kit



Mounting Bracket Kit

MBK-01

Mechanical

Weight	12.6 lbs (5.7 kg)
Hinge Pitch	47.25 in (1200 mm)
Mounting Pole Dimension	2 to 5 in (5 to 12 cm)
Fastener Size	M12
Installation Torque	40 ft·lb (54 N·m)
Mechanical Tilt Adjustment	0° - 10°

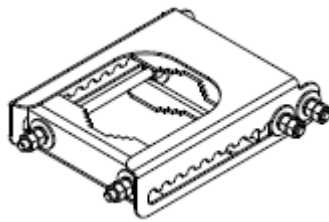

MBK-01 Top Adjustable Bracket

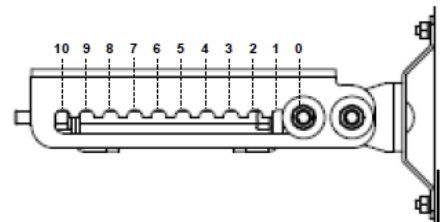

MBK-01 Top Adjustable Bracket Side View

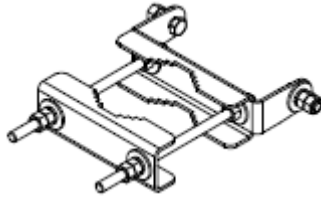

MBK-01 Bottom Fixed Bracket



Remote Electrical Tilt Actuator (RET)

BSA-RET200

General Specifications

Part Number	BSA-RET200
Protocols	AISG 2.0
RET Type	Type 1
Adjustment Cycles	>10,000 cycles
Tilt Accuracy	±0.1°
Temperature Range	-40° C to 70° C

Electrical

Data Interface Signal	DC
Input Voltage	10-30 Vdc
Current Consumption Tilt	120 mA at $V_{in}=24$
Current Consumption Idle	55 mA at $V_{in}=24$
Hardware Interface	AISG-RS 485 A/B
Input Connector	Male 1 × 8 pin Daisy Chain
Output Connector	Female 1 × 8 pin Daisy Chain

Mechanical

Dimensions (LxWxD)	8.0x5.0x2.0 in. (213x135x51 mm)
Housing	ASA/ABS/Aluminum
Weight	1.7 lbs (0.75 kg)

ASA= Acrylic Styrene Acrylonitrile
ABS=Acrylonitrile Butadiene Styrene

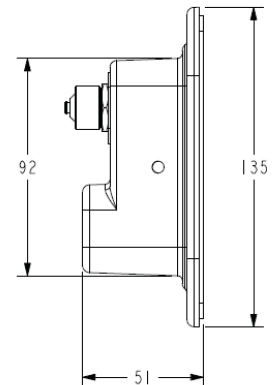
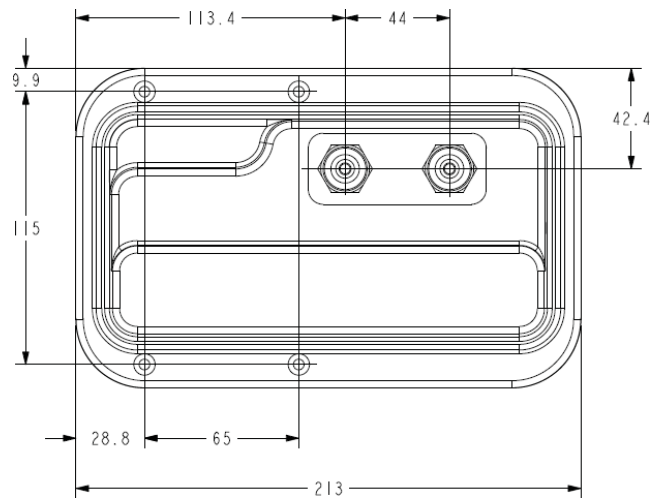



AISG Cable Kit

Electrical/Mechanical/Environmental Specifications

	RET to RET Cables	RRU to Antenna Cables
Individual Cable Part Number	AISGC-M-F-27	AISGC-M-F-10FT
Cable style	UL2464	
Protocol	AISG 1.1 and AISG 2.0	
Maximum voltage	300 V	
Rated current	5 A at 104° F (40° C)	
Temperature Range	-40° to 80° C	
Flammability	UL 1581 VW-1	
Ingress Protection	IEC 60529:2001, IP67	
Tightening torque	Hand tighten only ≈ 1.84 ft-lbs (2.5 N·m)	
Construction	Shielded (Tinned Copper Braid)	
Braid coverage	85%	
Jacket Material	Matte Polyurethane (Black)	
Conductors	1 twisted pair - 24 AWG 3 conductors - 19 AWG AWM style 2464	
Cable Diameter	0.307 in (7.8 mm)	
Minimum bend radius	3.9 in (100 mm)	
Connectors	2 x 8 pin IEC 60130-9 Straight male/straight female	
Length	27 in (686 mm)	120 in (3048 mm)
Weight	0.33 lbs (0.15 kg)	0.69 lbs (0.31 kg)
Cables per kit	2	2

Mechanical Specifications

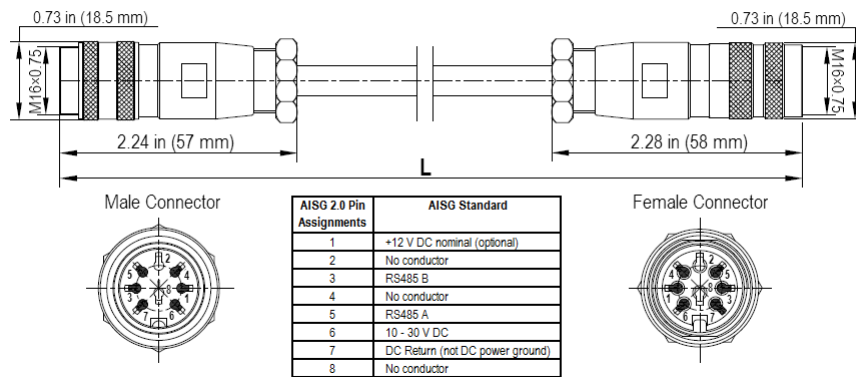

AISG-Male to AISG-Female Jumper Cable



Electrical/Mechanical/Environmental Specifications

Individual Cable Part Number	RET to RET Cables		RRU to Antenna Cables
	AISGC-MRA-FRA-22	AISGC-MRA-FRA-36	AISGC-M-FRA-10FT
Cable style	UL2464		
Protocol	AISG 1.1 and AISG 2.0		
Maximum voltage	300 V		
Rated current	5 A at 104° F (40° C)		
Temperature Range	-40° to 80° C		
Flammability	UL 1581 VW-1		
Ingress Protection	IEC 60529:2001, IP67		
Tightening torque	Hand tighten only ≈ 1.84 ft-lbs (2.5 N-m)		
Construction	Shielded (Tinned Copper Braid)		
Braid coverage	85%		
Jacket Material	Matte Polyurethane (Black)		
Conductors	1 twisted pair - 24 AWG 3 conductors - 19 AWG AWM style 2464		
Cable Diameter	0.307 in (7.8 mm)		
Minimum bend radius	3.9 in (100 mm)		
Connectors	2 x 8 pin IEC 60130-9 Right angle male/right angle female		2 x 8 pin IEC 60130-9 Straight male/right angle female
Length	22 in (559 mm)	36 in (914 mm)	120 in (3048 mm)
Weight	0.18 lbs (0.08 kg)	0.23 lbs (0.10 kg)	0.77 lbs (0.35 kg)
Cables per kit	1	1	2

Mechanical Specifications

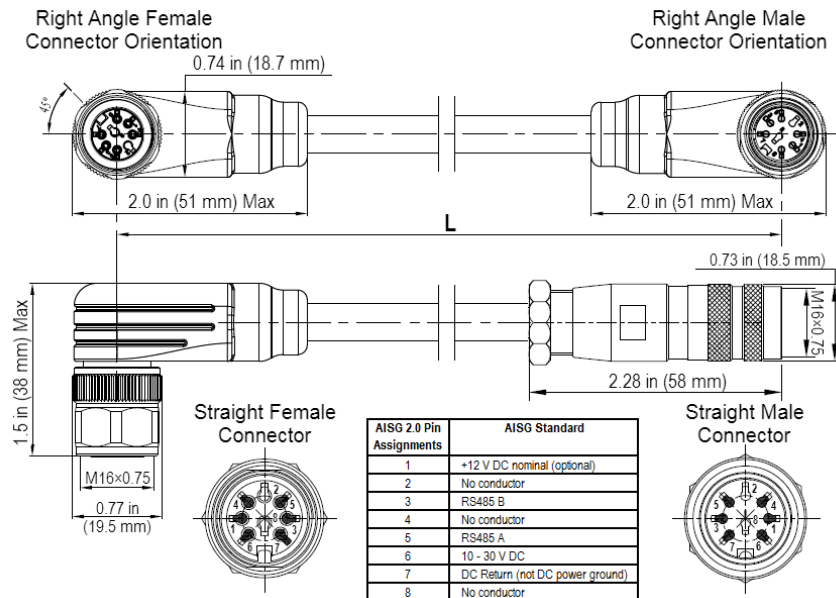

Right Angle to Right Angle and Right Angle to Straight Jumper Cable



AISG Cable Kit

CBK-AG-RRU-001

Electrical/Mechanical/Environmental Specifications

	RET to RET Cables	RRU to Antenna Cables
Individual Cable Part Number	AISGC-M-F-27	AISGC-M-F-10FT
Cable style	UL2464	
Protocol	AISG 1.1 and AISG 2.0	
Maximum voltage	300 V	
Rated current	5 A at 104° F (40° C)	
Temperature Range	-40° to 80° C	
Flammability	UL 1581 VW-1	
Ingress Protection	IEC 60529:2001, IP67	
Tightening torque	Hand tighten only ≈ 1.84 ft-lbs (2.5 N·m)	
Construction	Shielded (Tinned Copper Braid)	
Braid coverage	85%	
Jacket Material	Matte Polyurethane (Black)	
Conductors	1 twisted pair - 24 AWG 3 conductors - 19 AWG AWM style 2464	
Cable Diameter	0.307 in (7.8 mm)	
Minimum bend radius	3.9 in (100 mm)	
Connectors	2 x 8 pin IEC 60130-9 Straight male/straight female	
Length	27 in (686 mm)	120 in (3048 mm)
Weight	0.33 lbs (0.15 kg)	0.69 lbs (0.31 kg)
Cables per kit	1	2

Mechanical Specifications

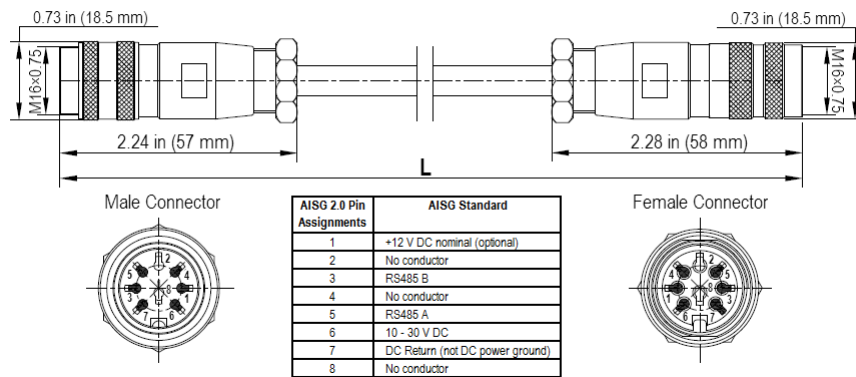

AISG-Male to AISG-Female Jumper Cable

Electrical/Mechanical/Environmental Specifications

	RET to RET Cables	RRU to Antenna Cables
Individual Cable Part Number	AISGC-MRA-FRA-36	AISGC-M-FRA-10FT
Cable style	UL2464	
Protocol	AISG 1.1 and AISG 2.0	
Maximum voltage	300 V	
Rated current	5 A at 104° F (40° C)	
Temperature Range	-40° to 80° C	
Flammability	UL 1581 VW-1	
Ingress Protection	IEC 60529:2001, IP67	
Tightening torque	Hand tighten only ≈ 1.84 ft-lbs (2.5 N·m)	
Construction	Shielded (Tinned Copper Braid)	
Braid coverage	85%	
Jacket Material	Matte Polyurethane (Black)	
Conductors	1 twisted pair - 24 AWG 3 conductors - 19 AWG AWM style 2464	
Cable Diameter	0.307 in (7.8 mm)	
Minimum bend radius	3.9 in (100 mm)	
Connectors	2 x 8 pin IEC 60130-9 Right angle male/right angle female	2 x 8 pin IEC 60130-9 Straight male/right angle female
Length	36 in (914 mm)	120 in (3048 mm)
Weight	0.23 lbs (0.10 kg)	0.77 lbs (0.35 kg)
Cables per kit	1	2

Mechanical Specifications

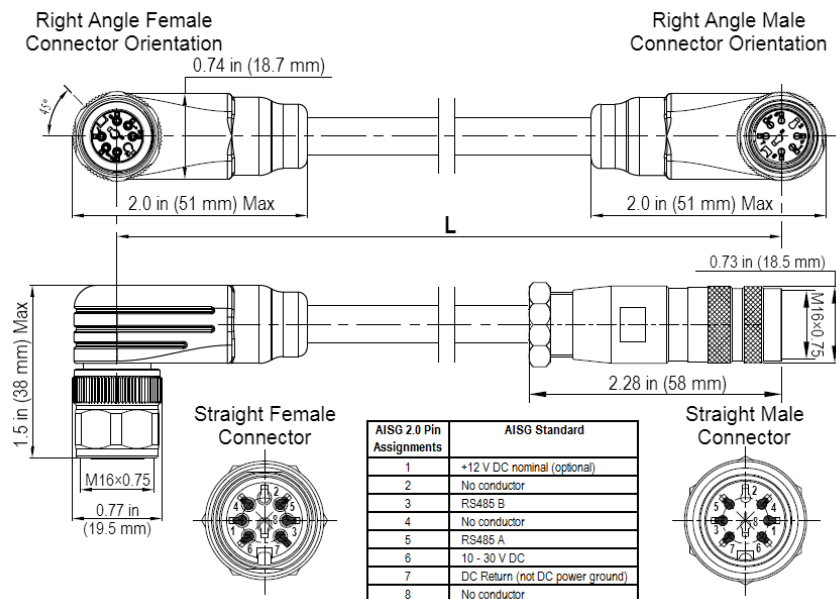

Right Angle to Right Angle and Right Angle to Straight Jumper Cable



STANDARDS & CERTIFICATIONS

TriBand Antenna

HPA45R-KE6A

Standards & Compliance

Safety	EN 60950-1, UL 60950-1
Emission	EN 55022
Immunity	EN 55024
Environmental	IEC 60068-2-1, IEC 60068-2-2, IEC 60068-2-5, IEC 60068-2-6, IEC-60068-2-11, IEC 60068-2-14, IEC 60068-2-18, IEC 60068-2-27, IEC 60068-2-29, IEC 60068-02-30, IEC 60068-2-52, IEC 60068-2-64, GR-63-CORE 4.3.1, EN 60529, IP 24

Certifications

Antenna Interface Standards Group (AISG), Federal Communication Commission (FCC) Part 15 Class B, CE, CSA US, ISO 9001

