

- 33° Azimuth Beamwidth covering wide range of frequency bands- (698-806 MHz); (824-896 MHz); (1850-1990 MHz); (1695-1755 / 2110-2180 MHz)
- Four high band ports and two low band ports in one antenna
- Excellent elevation side-lobe performance
- Excellent MIMO performance due to array spacing
- Rugged, reliable design with excellent PIM performance
- A multi-network solution in one radome
- 3GPP/AISG 2.0 compliant RET system with daisy chaining capability
- Reduces tower loading
- Frees up space for tower mounted E-nodes
- Single radome with six ports
- All Band design simplifies radio assignments
- Sharp elevation beam eases network planning

## Overview

The CCI Hexport 33° Multi-Band Antenna Array is a 6-port antenna with Multi-Band (One Low Band (698-896 MHz) and Two High Bands (1695-2180 MHz)) coverage. With four high band ports and two low band ports, our Hexport antenna is ready for 4X4 high band MIMO.

Modern networks demand high performance, consequently CCI has incorporated several new and innovative design techniques to provide an antenna with excellent side-lobe performance, sharp elevation beams, and high front to back ratio.

Multiple networks can now be connected to a single antenna, reducing tower loading and leasing expense, while decreasing deployment time and installation cost.

Full band capability for 700 MHz , Cellular 850 MHz, PCS 1900 MHz, and AWS 1710/2155 MHz in a single enclosure.

CCI antennas are designed and produced to ISO 9001 certification standards for reliability and quality in our state-of-the-art manufacturing facilities.

## Applications

- 4x4 MIMO for the high band and 2x2 MIMO for the low band
- Adding additional capacity without adding additional antennas
- Dense macro sites



HexPort Multi-Band Antenna

HPA-33R-BWW-H4

SPECIFICATIONS

Electrical

Ports	2 × Low Band Ports for 698-896 MHz		4 × High Band Ports for 1695-2180 MHz		
Frequency Range	698-806 MHz	824-896 MHz	1850-1990 MHz	1695-1755/2110-2180 MHz	
Gain (dBi)	15.3	16.5	18.1	17.4	18.5
Azimuth Beamwidth (-3dB) (°)	38	33	33	35	31
Elevation Beamwidth (-3dB) (°)	18.3	15.8	8.7	9.6	7.7
Electrical Downtilt (°)	2 to 10	2 to 10	0 to 8	0 to 8	0 to 8
Elevation Sidelobes (1st Upper) (dB)	< -18	< -18	< -18	< -18	< -17
Front-to-Back Ratio @180° (dB)	> 30	> 30	> 35	> 35	> 35
Cross-Polar Discrimination (at Peak) (dB)	> 25	> 25	> 25	> 25	> 22
Cross-Polar Port-to-Port Isolation (dB)	> 25	> 25	> 25	> 25	> 25
Voltage Standing Wave Ratio (VSWR)	< 1.5:1	< 1.5:1	< 1.5:1	< 1.5:1	< 1.5:1
Passive Intermodulation (2x20W) (dBc)	≤ -153	≤ -153	≤ -153	≤ -153	≤ -153
Input Power Continuous Wave (CW)	500 watts	500 watts	300 watts	300 watts	300 watts
Polarization	Dual Pol 45°	Dual Pol 45°	Dual Pol 45°	Dual Pol 45°	Dual Pol 45°
Input Impedance	50 ohms	50 ohms	50 ohms	50 ohms	50 ohms
Lightning Protection	DC Ground	DC Ground	DC Ground	DC Ground	DC Ground

BASTA Electrical Specifications*					
Frequency Range	698-806 MHz	824-896 MHz	1850-1990 MHz	1695-1755/2110-2180 MHz	
Gain over all Tilts (dBi)	15.3	16.5	18.1	17.4	18.5
Gain over all Tilts Tolerance (dB)	0.6	0.4	0.3	0.4	0.6
Gain at Low-tilt (dBi)	15.4	16.7	17.9	17.2	18.5
Gain at Mid-tilt (dBi)	15.4	16.6	18.2	17.5	18.7
Gain at High-tilt (dBi)	15.1	16.2	18.2	17.5	18.3
Azimuth Beamwidth Tolerance (°)	2.3	1.1	2.7	2.9	3.0
Elevation Beamwidth Tolerance (°)	1.7	0.9	0.5	0.3	0.5
Electrical Downtilt Deviation (°)	1.0	0.7	0.8	0.7	1.0
Front-to-Back Ratio over ± 20° (dB)	22.9	24.7	27.0	28.0	26.6
First Upper Sidelobe Suppression (dB)	16.5	19.2	21.2	19.4	17.3
Upper Sidelobe Suppression, peak to 20° (dB)	N/A	18.6	20.5	20.2	16.6

\* Electrical specifications follow document "Recommendation on Base Station Antenna Standards" (BASTA) V9.6. All specifications are subject to change without notice.

Mechanical

Dimensions (LxWxD)	50.5x23.1x8.8 in (1283x587x224 mm)
Survival Wind Speed	> 125 mph (> 201 kph)
Front Wind Load	249 lbs (1108 N) @ 100 mph (161 kph)
Side Wind Load	106 lbs (473 N) @ 100 mph (161 kph)
Equivalent Flat Plate Area	9.7 ft <sup>2</sup> (0.9 m <sup>2</sup> )
Weight *	52.2 lbs (23.7 kg)
RET System Weight	5.0 lbs (2.3 kg)
Connector	6 × 7-16 DIN female long neck
Mounting Pole	2 to 5 in (5 to 12 cm)

\* Weight excludes mounting and RET



# HexPort Multi-Band Antenna

HPA-33R-BWW-H4

## SPECIFICATIONS

Bottom View

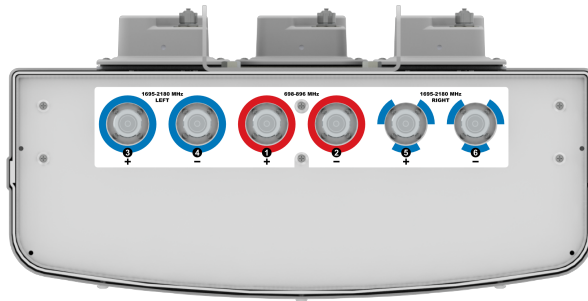

RET Connection Diagram

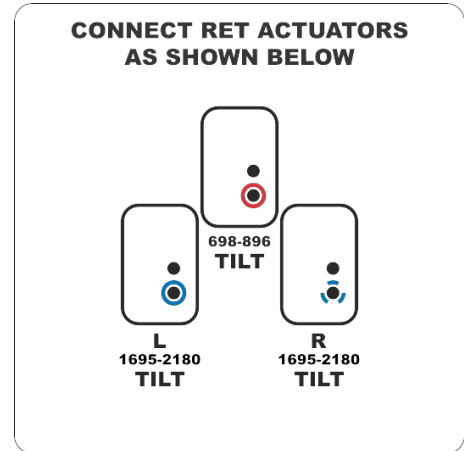

## Mechanical

Connector Spacing

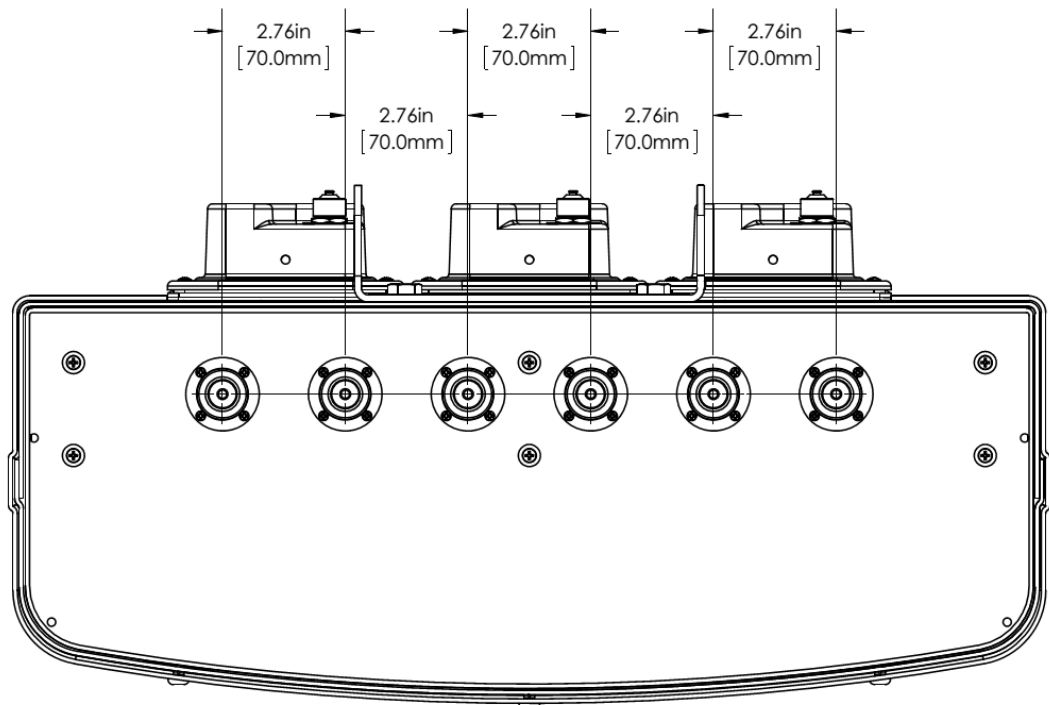



SPECIFICATIONS

HexPort Multi-Band Antenna

HPA-33R-BWW-H4

Typical Antenna Patterns

For detailed information on additional antenna patterns, contact customer support at support@cciproducts.com

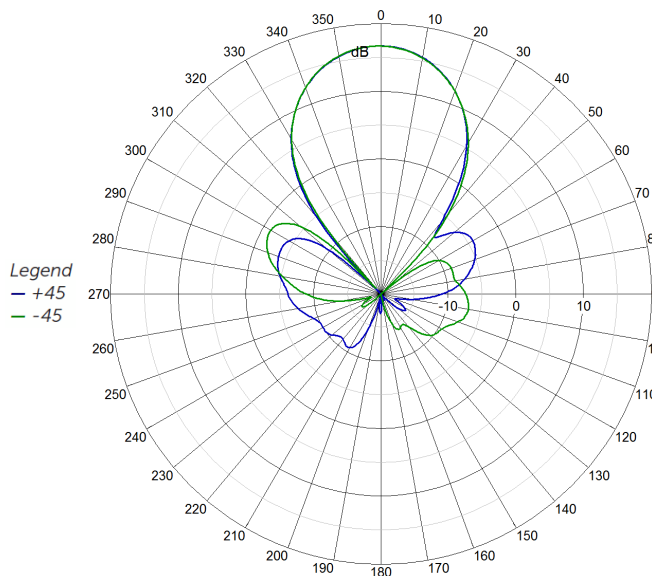

875 MHz Azimuth

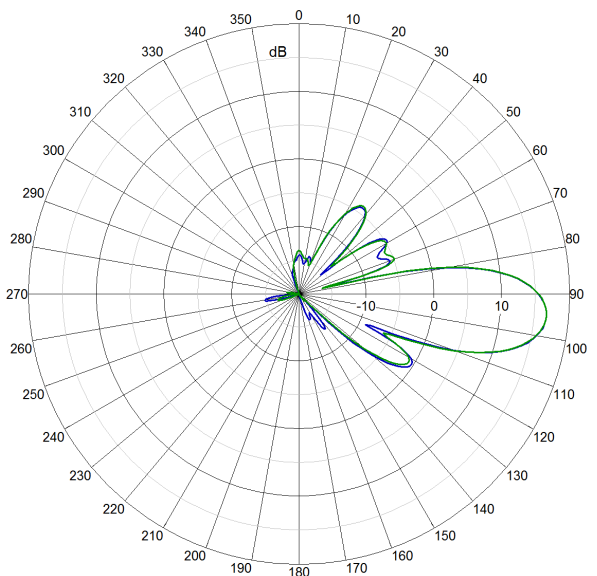

875 MHz Elevation 6°

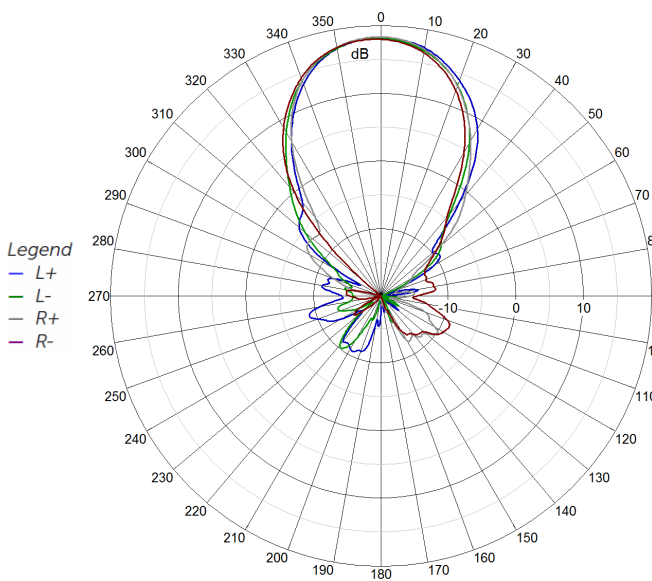

1948 MHz Azimuth

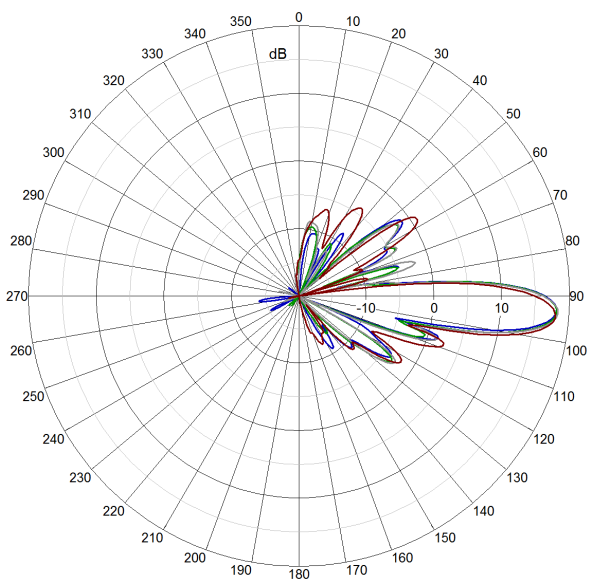

1948 MHz Elevation 4°



ORDERING

HexPort Multi-Band Antenna

HPA-33R-BWW-H4

Parts & Accessories

<b>HPA-33R-BWW-H4</b>	Four foot (1.3 m) HexPort antenna with 33° azimuth beamwidth, 3 factory installed BSA-RET200 RET actuators and MBK-02 mounting bracket
<b>MBK-02</b>	Mounting bracket kit (top and bottom) with 0° to 10° mechanical tilt adjustment
<b>BSA-RET200</b>	Remote electrical tilt actuator
<b>HPA-CBK-AG-RRU</b>	HexPort antenna to RRU AISG cable kit
<b>HPA-CBK-RA-AG-RRU</b>	HexPort antenna to RRU AISG right angle cable kit



Mounting Bracket Kit

MBK-02

Mechanical

Weight	9.8 lbs (4.4 kg)
Hinge Pitch	31.5 in (800 mm)
Mounting Pole Dimension	2 to 5 in (5 to 12 cm)
Fastener Size	M10
Installation Torque	15 ft-lbs (20 N-m)
Mechanical Tilt Adjustment	0° - 10°

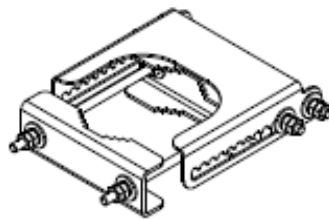

MBK-02 Top Adjustable Bracket

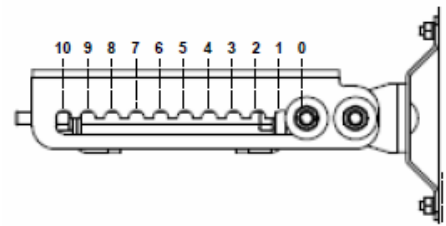

MBK-02 Top Adjustable Bracket Side View

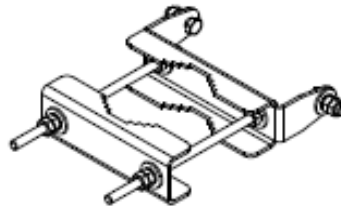

MBK-02 Bottom Fixed Bracket



### Remote Electrical Tilt Actuator (RET)

BSA-RET200

#### General Specifications

Part Number	BSA-RET200
Protocols	AISG 2.0
RET Type	Type 1
Adjustment Cycles	>10,000 cycles
Tilt Accuracy	±0.1°
Temperature Range	-40° C to 70° C

#### Electrical

Data Interface Signal	DC
Input Voltage	10-30 Vdc
Current Consumption Tilt	120 mA at $V_{in}=24$
Current Consumption Idle	55 mA at $V_{in}=24$
Hardware Interface	AISG-RS 485 A/B
Input Connector	Male 1 × 8 pin Daisy Chain
Output Connector	Female 1 × 8 pin Daisy Chain

#### Mechanical

Dimensions (LxWxD)	8.0x5.0x2.0 in. (213x135x51 mm)
Housing	ASA/ABS/Aluminum
Weight	1.7 lbs (0.75 kg)

ASA= Acrylic Styrene Acrylonitrile  
ABS=Acrylonitrile Butadiene Styrene

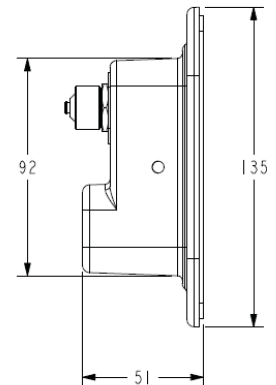
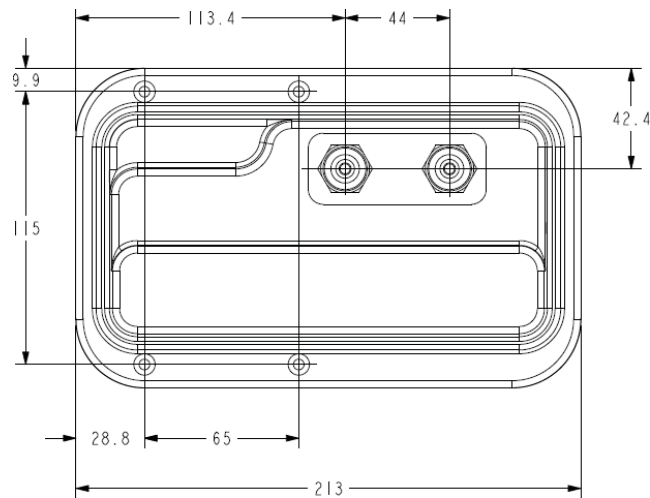



Electrical Specifications

<b>Individual Cable Part Number</b>	AISGC-M-F-18	AISGC-M-F-10FT
<b>Cable style</b>	UL2464	UL2464
<b>Protocol</b>	AISG 1.1 and AISG 2.0	AISG 1.1 and AISG 2.0
<b>Maximum voltage</b>	300 V	300 V
<b>Rated current</b>	5 A at 104° F (40° C)	5 A at 104° F (40° C)

Mechanical Specifications

<b>Individual Cable Part Number</b>	AISGC-M-F-18	AISGC-M-F-10FT
<b>Cables per kit</b>	2	2
<b>Connectors</b>	2 x 8 pin IEC 60130-9 Straight male/straight female	2 x 8 pin IEC 60130-9 Straight male/straight female
<b>Tightening torque</b>	Hand tighten only ≈ 1.84 ft-lbs (2.5 N-m)	Hand tighten only ≈ 1.84 ft-lbs (2.5 N-m)
<b>Construction</b>	Shielded (Tinned Copper Braid)	Shielded (Tinned Copper Braid)
<b>Braid coverage</b>	85%	85%
<b>Jacket Material</b>	Matte Polyurethane (Black)	Matte Polyurethane (Black)
<b>Conductors</b>	1 twisted pair - 24 AWG 3 conductors - 19 AWG AWM style 2464	1 twisted pair - 24 AWG 3 conductors - 19 AWG AWM style 2464
<b>Cable Diameter</b>	0.307 in (7.8 mm)	0.307 in (7.8 mm)
<b>Length</b>	18 - 20 in (457 - 508 mm)	120 in (3048 mm)
<b>Weight</b>	0.27 lbs (0.12 kg)	0.69 lbs (.31 kg)
<b>Minimum bend radius</b>	3.9 in (100 mm)	3.9 in (100 mm)

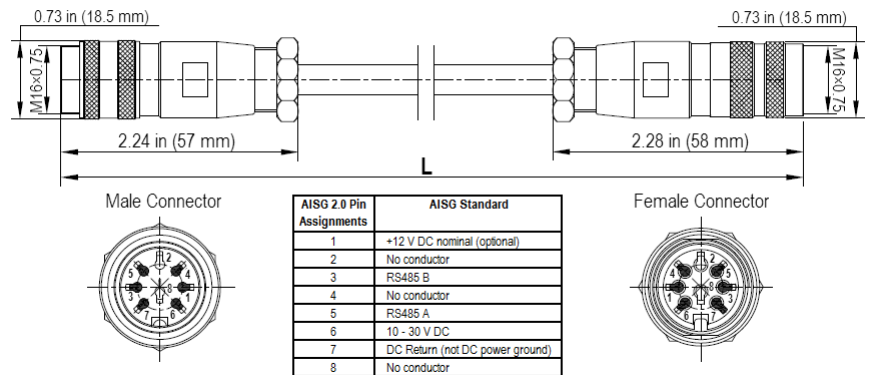

AISG-Male to AISG-Female Jumper Cable

Environmental Specifications

<b>Individual Cable Part Number</b>	AISGC-M-F-18	AISGC-M-F-10FT
<b>Temperature Range</b>	-40° to 80° C	-40° to 80° C
<b>Flammability</b>	UL 1581 VW-1	UL 1581 VW-1
<b>Ingress Protection</b>	IEC 60529:2001, IP67	IEC 60529:2001, IP67



## Electrical/Mechanical/Environmental Specifications

	RET to RET Cables	RRU to Antenna Cables
Individual Cable Part Number	AISGC-MRA-FRA-20	AISGC-M-FRA-10FT
Cable style	UL2464	
Protocol	AISG 1.1 and AISG 2.0	
Maximum voltage	300 V	
Rated current	5 A at 104° F (40° C)	
Temperature Range	-40° to 80° C	
Flammability	UL 1581 VW-1	
Ingress Protection	IEC 60529:2001, IP67	
Tightening torque	Hand tighten only ≈ 1.84 ft-lbs (2.5 N·m)	
Construction	Shielded (Tinned Copper Braid)	
Braid coverage	85%	
Jacket Material	Matte Polyurethane (Black)	
Conductors	1 twisted pair - 24 AWG 3 conductors - 19 AWG AWM style 2464	
Cable Diameter	0.307 in (7.8 mm)	
Minimum bend radius	3.9 in (100 mm)	
Connectors	2 x 8 pin IEC 60130-9 Right angle male/right angle female	2 x 8 pin IEC 60130-9 Straight male/right angle female
Length	20 in (508 mm)	120 in (3048 mm)
Weight	0.23 lbs (0.10 kg)	0.77 lbs (0.35 kg)
Cables per kit	2	2

## Mechanical Specifications

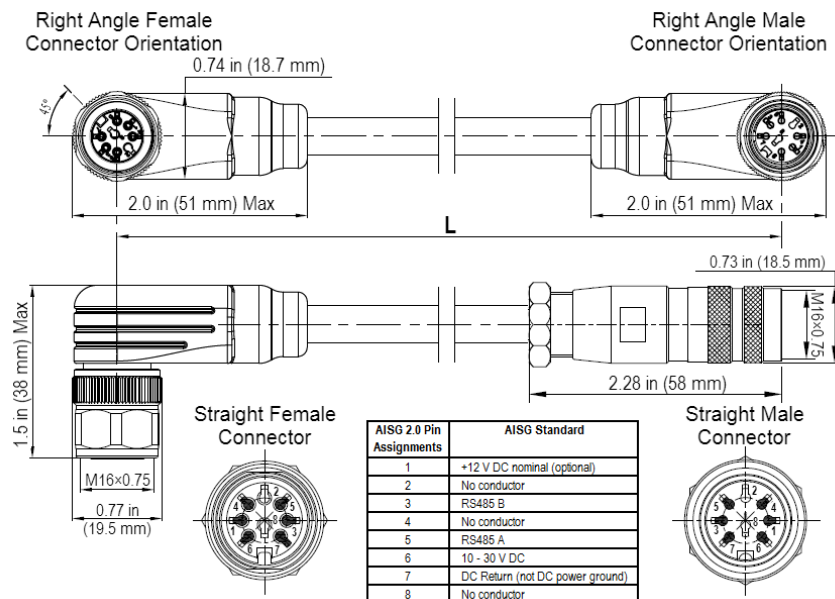

Right Angle to Right Angle and Right Angle to Straight Jumper Cable



STANDARDS & CERTIFICATIONS

HexPort Multi-Band Antenna

HPA-33R-BWW-H4

Standards & Compliance

<b>Safety</b>	EN 60950-1, UL 60950-1
<b>Emission</b>	EN 55022
<b>Immunity</b>	EN 55024
<b>Environmental</b>	IEC 60068-2-1, IEC 60068-2-2, IEC 60068-2-5, IEC 60068-2-6, IEC-60068-2-11, IEC 60068-2-14, IEC 60068-2-18, IEC 60068-2-27, IEC 60068-2-29, IEC 60068-02-30, IEC 60068-2-52, IEC 60068-2-64, GR-63-CORE 4.3.1, EN 606529, IP 24

Certifications

Antenna Interface Standards Group (AISG), Federal Communication Commission (FCC) Part 15 Class B, CE, CSA US, ISO 9001

