



Antennas

DATA SHEET

Dual Band Bi-Sector™ Array

BSA33R-BU8A



- Eight foot (2.4 m), multiband, Sixteen port Dual Band Bi-Sector™ Antenna. Deploying two independent high performing pairs of CCI's Patented Asymmetrical 33° Shaped Beams covering 698-896 MHz and 1695-2400 MHz frequencies
- Eight wide high band ports covering 1695-2400 MHz and eight wide low band ports covering 698-896 MHz in a single antenna
- Full Spectrum Compliance for 698-896 MHz /1695-2400 MHz
- Provides two independent pairs of LTE Optimized Asymmetric Shaped Beams for improved LTE data throughput by minimizing beam crossover, providing for an efficient use of valuable radio capacity and frequency spectrum
- LTE Optimized FBR, SPR and Boresight/Sector XPD Performance, essential for today's LTE Data Networks
- Exceeds minimum PIM performance requirements
- Equipped with new 4.3-10 connector, which is 40% smaller than traditional 7/16 DIN connector
- Equipped with Four Field Replaceable, integrated AISG 2.0 compliant Remote Electrical Tilt (RET)

Overview

This version of the CCI Dual Band Bi-Sector™ Multiband Array is a Sixteen port antenna, with eight wide high band ports covering 1695-2400 MHz and eight wide low band ports covering 698-896 MHz. The CCI Dual Band Bi-Sector™ array uses two independent pairs of CCI's Patented Asymmetric 33° Shaped Beams in the High Band frequencies and low band frequencies. The CCI Dual Band Bi-Sector™ Array thus provides the capability to deploy Dual (over split beams) 4x4 Multiple-input Multiple-output (MIMO) in the high band and (over split beams) 4x4 Multiple-input Multiple-output (MIMO) in the low band. The CCI Dual Band Bi-Sector™ Array utilizes four RET controllers, with a separate RET control in the Low Band and High Band for each LEFT and RIGHT pair of CCI's Patented Asymmetric 33° Shaped Beams.

The CCI Dual Band Bi-Sector™ Multiband Array, allow operators to reduce antenna count and replace existing 65° networks, while increasing cell site capacity and LTE data throughput by minimizing overlap between CCI's Patented Asymmetric 33° Shaped Beams. This design approach lowers interference between sectors. All of this is achieved through a single panel array, producing significant CAPEX and OPEX cost savings for the operator.

CCI antennas are designed and produced to ISO 9001 certification standards for reliability and quality in our state-of-the-art manufacturing facilities.

Applications

- Two Independent pairs of Dual (over split beams) 4x4 MIMO on High Band and Low Band
- Ready for Network Standardization on 4.3-10 connectors
- Ideal Antenna Solution for structurally constrained sites, where data throughput, capacity and limited spectrum is a concern
- With CCI's Dual Band Bi-Sector™ Antenna, wireless operators can connect multiple platforms to a single antenna, reducing tower load, lease expense, deployment time and installation cost



Antennas

SPECIFICATIONS

Dual Band Bi-Sector™ Array

BSA33R-BU8A

Electrical

Ports	8 × Low Band Ports for 698-896 MHz		
	698-806 MHz	790-862 MHz	824-896 MHz
Frequency Range	698-806 MHz	790-862 MHz	824-896 MHz
Gain ¹	16.3 dBi	16.7 dBi	17.1 dBi
Gain (Average) ²	15.2 dBi	16.0 dBi	16.3 dBi
Azimuth Beamwidth (-3dB)	35°	34°	33°
Elevation Beamwidth (-3dB)	17.7°	16.0°	15.1°
Electrical Downtilt	2° to 16°	2° to 16°	2° to 16°
Elevation Sidelobes (1st Upper)	< -16 dB	< -17 dB	< -17 dB
Front-to-Back Ratio @180°	> 35 dB	> 35 dB	> 35 dB
Cross-Polar Discrimination at Peak	> 22 dB	> 23 dB	> 23 dB
Cross-Polar Discrimination at 3 dB ²	7.6 dB	10.6 dB	11.6 dB
Cross-Polar Port-to-Port Isolation	> 25 dB	> 25 dB	> 25 dB
Co-Pol isolation (Worse Case)	> 17 dB*	> 17 dB	> 17 dB
Voltage Standing Wave Ratio (VSWR)	< 1.5:1	< 1.5:1	< 1.5:1
Passive Intermodulation (2x20W)	≤ -153 dBc	≤ -153 dBc	≤ -153 dBc
Input Power Continuous Wave (CW)	500 watts	500 watts	500 watts
Polarization	Dual Linear 45°	Dual Linear 45°	Dual Linear 45°
Input Impedance	50 ohms	50 ohms	50 ohms
Lightning Protection	DC Ground	DC Ground	DC Ground

¹Peak gain across sub-bands.

²Electrical specifications follow document "Recommendation on Base Station Antenna Standards" (BASTA) V11.1.

*> 710 MHz

All specifications are subject to change without notice.



Antennas

SPECIFICATIONS

Dual Band Bi-Sector™ Array

BSA33R-BU8A

Ports	8 × High Band Ports for 1695-2400 MHz			
	1695-1880 MHz	1850-1990 MHz	1920-2180 MHz	2300-2400 MHz
Frequency Range	1695-1880 MHz	1850-1990 MHz	1920-2180 MHz	2300-2400 MHz
Gain ¹	17.3 dBi	17.7 dBi	18.2 dBi	18.4 dBi
Gain (Average) ²	16.4 dBi	17.1 dBi	17.2 dBi	17.5 dBi
Azimuth Beamwidth (-3dB)	36°	33°	31°	28°
Elevation Beamwidth (-3dB)	9.1°	8.1°	7.6°	6.8°
Electrical Downtilt	2° to 10°	2° to 10°	2° to 10°	2° to 10°
Elevation Sidelobes (1st Upper)	<-18 dB	<-17 dB	<-17 dB	<-18 dB
Front-to-Back Ratio @180°	> 35 dB	> 35 dB	> 35 dB	> 35 dB
Cross-Polar Discrimination at Peak	> 25 dB	> 25 dB	> 25 dB	> 23 dB
Cross-Polar Discrimination at 3 dB ²	15.9 dB	15.1 dB	13.4 dB	10.9 dB
Cross-Polar Port-to-Port Isolation	> 25 dB	> 25 dB	> 25 dB	> 25 dB
Co-Pol isolation (Worse Case)	> 30 dB	> 30 dB	> 30 dB	> 30 dB
Voltage Standing Wave Ratio (VSWR)	< 1.5:1	< 1.5:1	< 1.5:1	< 1.5:1
Passive Intermodulation (2x20W)	≤ -153 dBc	≤ -153 dBc	≤ -153 dBc	≤ -153 dBc
Input Power Continuous Wave (CW)	300 watts	300 watts	300 watts	300 watts
Polarization	Dual Linear 45°	Dual Linear 45°	Dual Linear 45°	Dual Linear 45°
Input Impedance	50 ohms	50 ohms	50 ohms	50 ohms
Lightning Protection	DC Ground	DC Ground	DC Ground	DC Ground

¹Peak gain across sub-bands.

²Electrical specifications follow document "Recommendation on Base Station Antenna Standards" (BASTA) V11.1. All specifications are subject to change without notice.

Mechanical

Dimensions (LxWxD)	95.9x28.5x9.7 in (2436x723x245 mm)
Survival Wind Speed	> 150 mph (> 241 kph)
Front Wind Load	601 lbs (2673 N) @ 100 mph (161 kph)
Side Wind Load	247 lbs (1097 N) @ 100 mph (161 kph)
Equivalent Flat Plate Area	23.5 ft ² (2.2 m ²)
Weight *	153.4 lbs (69.6 kg)
Connector	16 × 4.3-10 female
Mounting Pole	3 to 5 in (7.5 to 12.7 cm)

* Weight excludes mounting



Antennas

SPECIFICATIONS

Dual Band Bi-Sector™ Array

BSA33R-BU8A

Bottom View

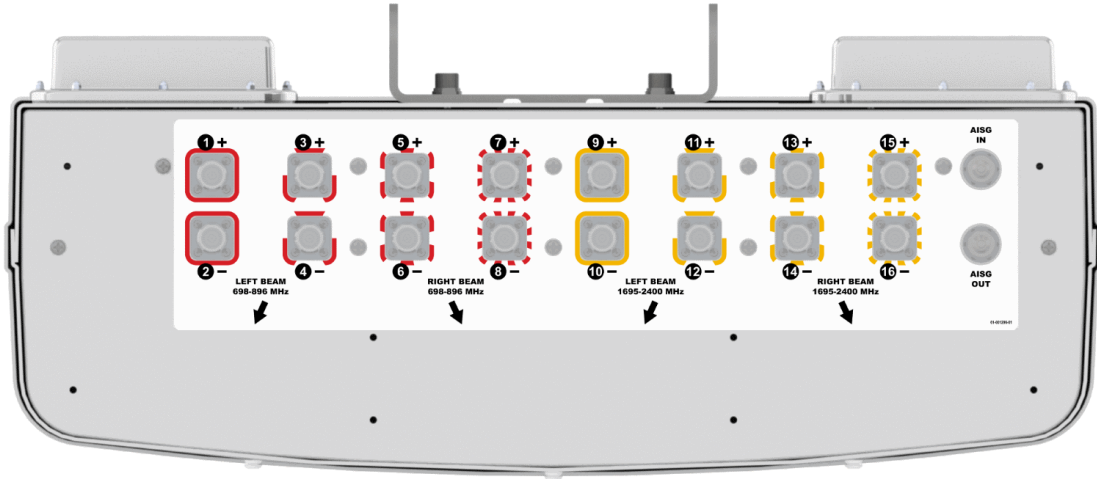

Connector Spacing

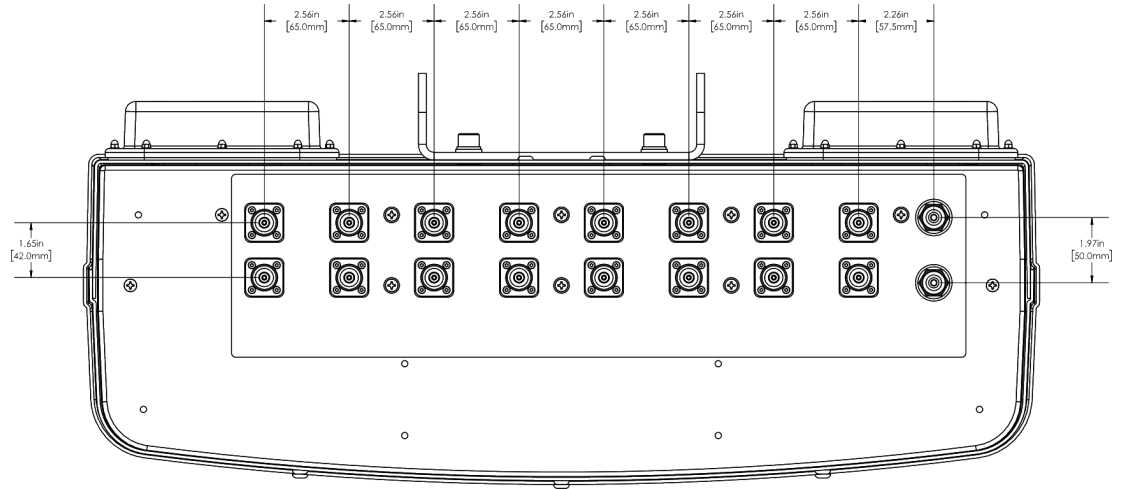



Antennas

SPECIFICATIONS

Dual Band Bi-Sector™ Array

BSA33R-BU8A

Mechanical

RET to Element Configuration

BSA33R-BU8AA Element and RET configuration (Type 17 Internal RET)

Top of antenna Viewed from rear

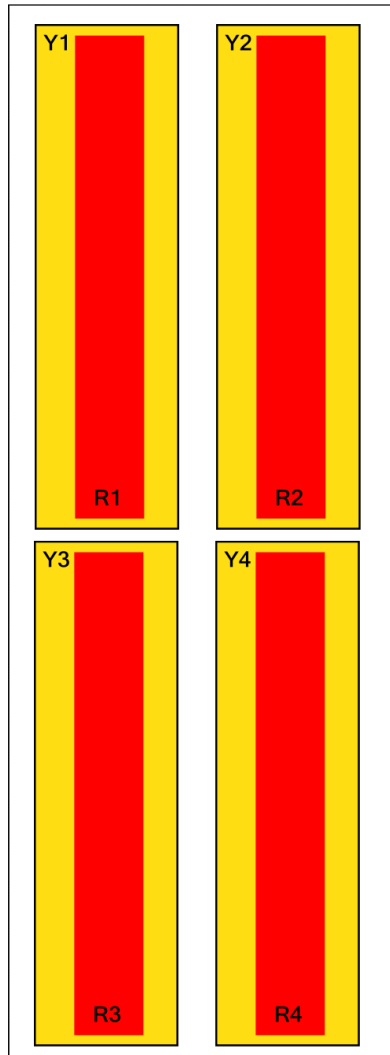

RET placement as view from rear of antenna

Top of antenna

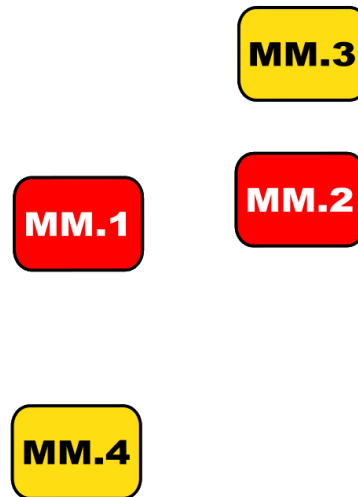

Array	Ports	Freq (MHz)	Ports controlled by common RET	AISG RET UID
R1	1, 2	698-896	1, 2, 3, 4 (Left Beams)	C1xxxxxxxMM.1
R3	3, 4	698-896		
R2	5, 6	698-896	5, 6, 7, 8 (Right Beams)	C1xxxxxxxMM.2
R4	7, 8	698-896		
Y1	9, 10	1695-2400	9, 10, 11, 12 (Left Beams)	C1xxxxxxxMM.3
Y2	11, 12	1695-2400		
Y3	13, 14	1695-2400	13, 14, 15, 16 (Right Beams)	C1xxxxxxxMM.4
Y4	15, 16	1695-2400		



Antennas

SPECIFICATIONS

Dual Band Bi-Sector™ Array

BSA33R-BU8A

Typical Antenna Patterns

For detailed information on additional antenna patterns, contact customer support at support@cciproducts.com

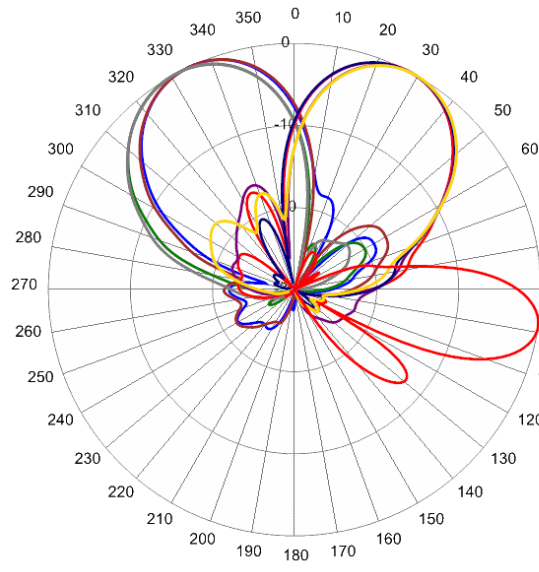

758 MHz Azimuth with Elevation 9°

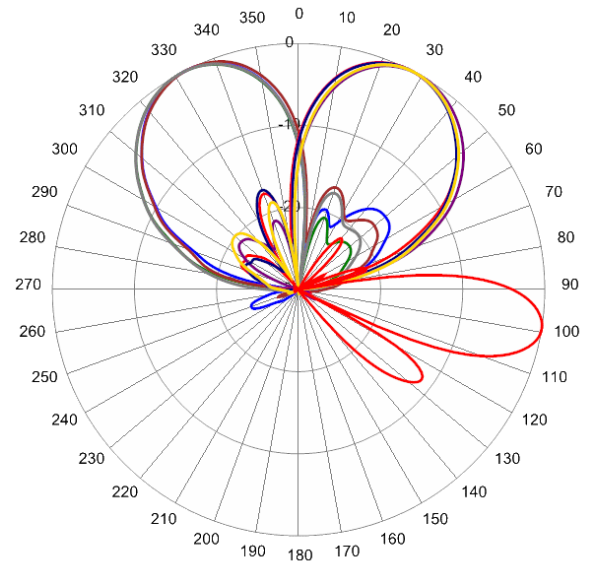

850 MHz Azimuth with Elevation 9°



Antennas

SPECIFICATIONS

Dual Band Bi-Sector™ Array

BSA33R-BU8A

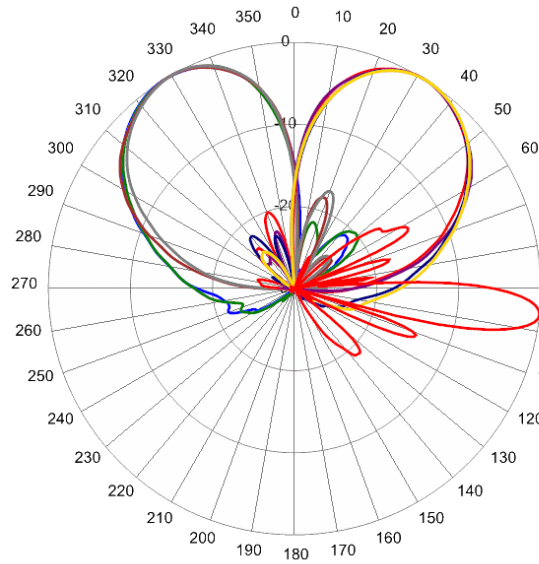

1780 MHz Azimuth with Elevation 6°

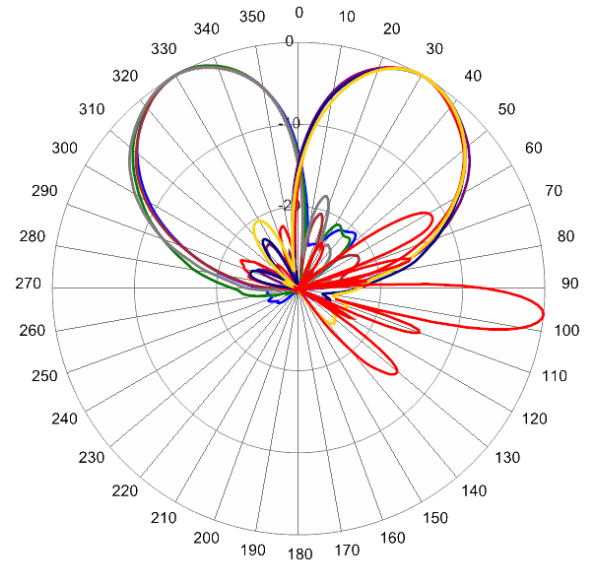

1920 MHz Azimuth with Elevation 6°

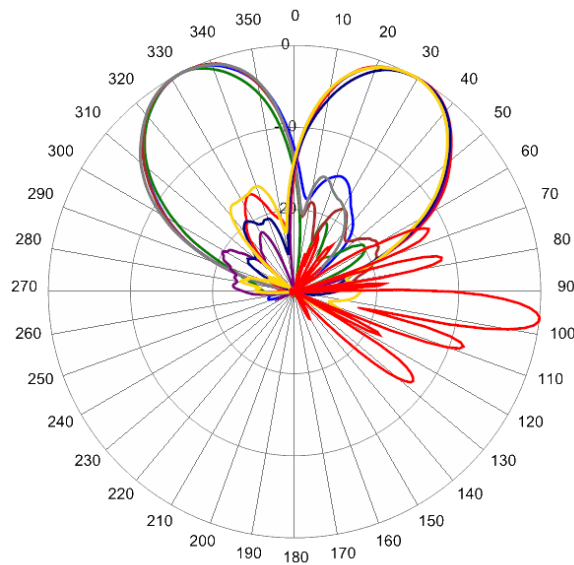

2180 MHz Azimuth with Elevation 6°

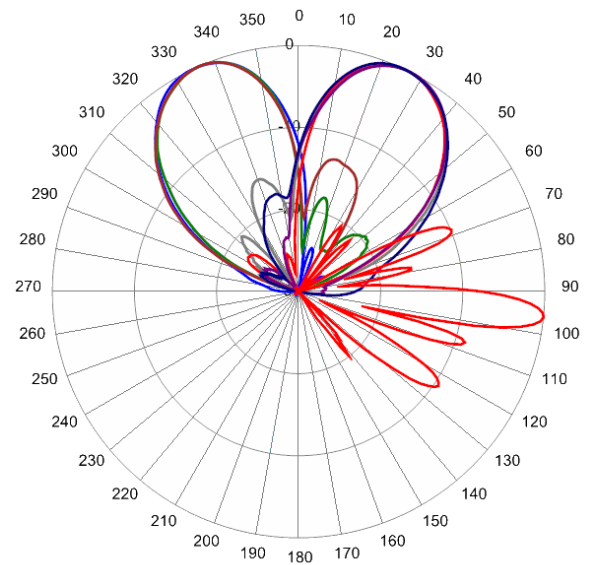

2360 MHz Azimuth with Elevation 6°



Antennas

ORDERING

Dual Band Bi-Sector™ Array

BSA33R-BU8A

Parts & Accessories

BSA33R-BU8AA-K	Eight foot (2.4 m) Bi-Sector™ Antenna Array with 4.3-10 female connectors, 4 factory installed BSA-RET400 RET actuators (Type 17 internal) and MBK-22 mounting brackets
MBK-22	Mounting bracket kit (top and bottom) with 0° to 10° mechanical tilt
MBK-23	Mounting bracket kit (top and bottom) with fixed 0° mechanical tilt
BSA-RET400	Type 17 Internal Remote Electrical Tilt System (RET)
AISGC-M-F-10FT	10 Ft (3 m) Male/Female RRU to Antenna AISG cable



Antennas

ACCESSORIES

Mounting Bracket Kit

MBK-22

Mechanical

Weight	39.9 lbs (18.1 kg)
Hinge Pitch	47.25 in (1200 mm)
Mounting Pole Dimension	3 to 5 in (7.5 to 12 cm)
Fastener Size	M12
Installation Torque	40 ft·lb (54 N·m)
Mechanical Tilt Adjustment	0° - 10°

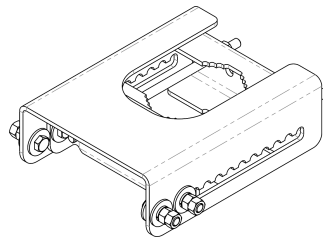

MBK-22 Top Adjustable Bracket

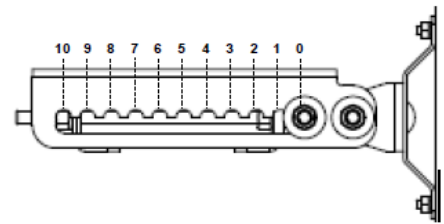

MBK-22 Top Adjustable Bracket Side View

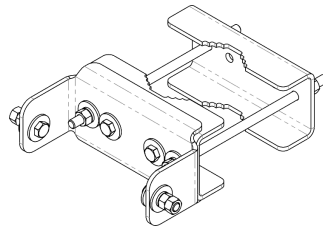

MBK-22 Bottom Fixed Bracket



Antennas

ACCESSORIES

Mounting Bracket Kit

MBK-23

Mechanical

Weight	31.7 lbs (14.4 kg)
Hinge Pitch	47.25 in (1200 mm)
Mounting Pole Dimension	3 to 5 in (7.5 to 12 cm)
Fastener Size	M12
Installation Torque	40 ft·lb (54 N·m)
Mechanical Tilt	0°

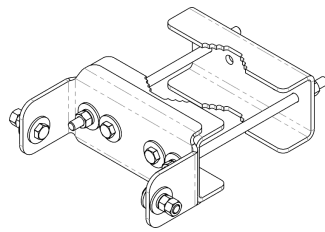

MBK-23 Top Fixed Bracket

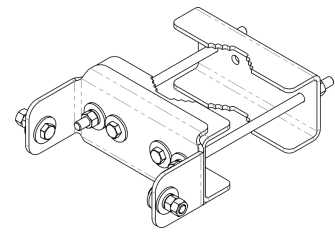

MBK-23 Bottom Fixed Bracket



Antennas

ACCESSORIES

Internal Remote Electrical Tilt (iRET)

BSA-RET400

General Specifications

Part Number	BSA-RET400
Protocols	AISG 2.0
RET Type	Type 17
Adjustment Cycles	>10,000 cycles
Tilt Accuracy	±0.1°
Temperature Range	-40° C to 70° C

Electrical

Data Interface Signal	DC
Input Voltage	10-30 Vdc
Current Consumption Tilt	100 mA at $V_{in}=24$ (500 mA MAX)
Current Consumption Idle	10 mA at $V_{in}=24$

Mechanical

Dimensions (LxWxD)	7.0x5.3x1.8 in. (179x134x45 mm)
Housing	ASA/ABS/Aluminum
Weight	1.3 lbs (0.6 kg)

ASA= Acrylic Styrene Acrylonitrile
ABS=Acrylonitrile Butadiene Styrene

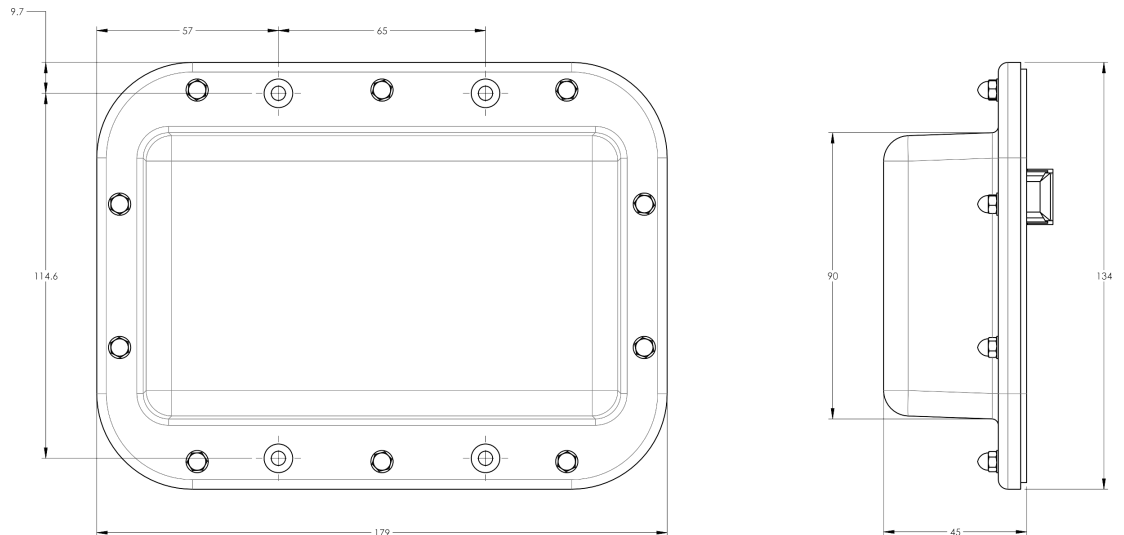



Antennas

ACCESSORIES

AISG Cable

AISGC-M-F-xFT

Electrical Specifications

Individual Cable Part Number	AISGC-M-F-x(FT)
Cable style	UL2464
Protocol	AISG 1.1 and AISG 2.0
Maximum voltage	300 V
Rated current	5 A at 104° F (40° C)

Mechanical Specifications

Individual Cable Part Number	AISGC-M-F-x(FT)
Cables per kit	1
Connectors	2 x 8 pin IEC 60130-9 Straight male/straight female
Tightening torque	Hand tighten only \approx 1.84 ft-lbs (2.5 Nm)
Construction	Shielded (Tinned Copper Braid)
Braid coverage	85%
Jacket Material	Matte Polyurethane (Black)
Conductors	1 twisted pair - 24 AWG 3 conductors - 19 AWG AWM style 2464
Cable Diameter	0.307 in (7.8 mm)
Length	See order details
Minimum bend radius	3.15 in (80 mm)

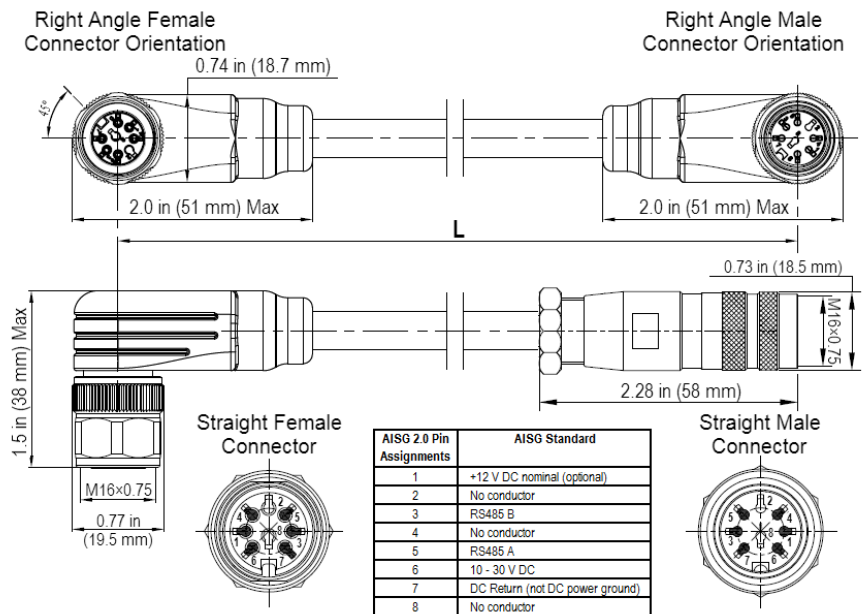

AISG-Male to AISG-Female Jumper Cable



Antennas

ACCESSORIES

AISG Cable

AISGC-M-F-xFT

Environmental Specifications

Individual Cable Part Number	AISGC-M-F-xFT
Temperature Range	-40° to 80° C
Flammability	UL 1581 VW-1
Ingress Protection	IEC 60529:2001, IP67



Antennas

STANDARDS & CERTIFICATIONS

Dual Band Bi-Sector™ Array

BSA33R-BU8A

Standards & Compliance

Safety	EN 60950-1, UL 60950-1
Emission	EN 55022
Immunity	EN 55024
Environmental	IEC 60068-2-1, IEC 60068-2-2, IEC 60068-2-5, IEC 60068-2-6, IEC-60068-2-11, IEC 60068-2-14, IEC 60068-2-18, IEC 60068-2-27, IEC 60068-2-29, IEC 60068-02-30, IEC 60068-2-52, IEC 60068-2-64, GR-63-CORE 4.3.1, EN 60529, IP 24

Certifications

Antenna Interface Standards Group (AISG), Federal Communication Commission (FCC) Part 15 Class B, CE, CSA US, ISO 9001



CCI Communication Components Inc.
EXTENDING WIRELESS PERFORMANCE